



DOUBLE-SHEET

INDUCTIVE SENSORS

KEY ADVANTAGES

- ✓ Double-sheet detection (steel and aluminum) with sensitivity of 0.8 - 1.2 mm per sheet
- ✓ Full Inox: extremely robust one-piece stainless-steel housing
- ✓ Corrosion resistant
- ✓ IP 68 and IP 69K
- ✓ Pressure resistant up to 80 bar

RANGE OVERVIEW	Housing size	Full Inox
DOUBLE-SHEET	M30	p. 161

FAMILY

HOUSING SIZE MM

OPERATING DISTANCE MM

INDUCTIVE

WIRING DIAGRAM

PNP NO

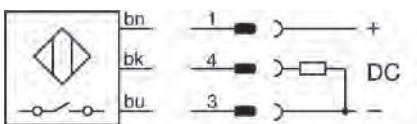

DATA

Housing material

Connection

Degree of protection

Mounting

Max. switching frequency

Supply voltage range

Ambient temperature range

Output current

PNP NO

Description

DOUBLE-SHEET

FULL INOX		
M30		
3 ... 5		

Inductive



Photoelectric

Safety

RFID

Connectivity

Accessories

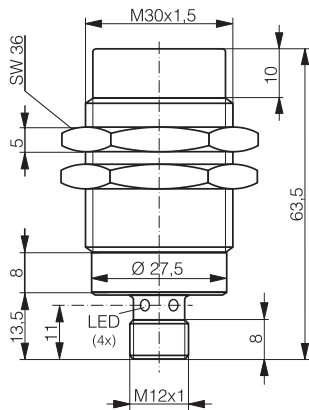

Glossary

Stainless steel V2A		
Connector S12		
IP 68 / IP 69K		
Non-embeddable		
10 Hz		
10 ... 30 VDC		
-25 ... +70°C / -13 ... +158°F		
≤ 200 mA		
DW-AS-713-M30-618		
Double-sheet		

Index

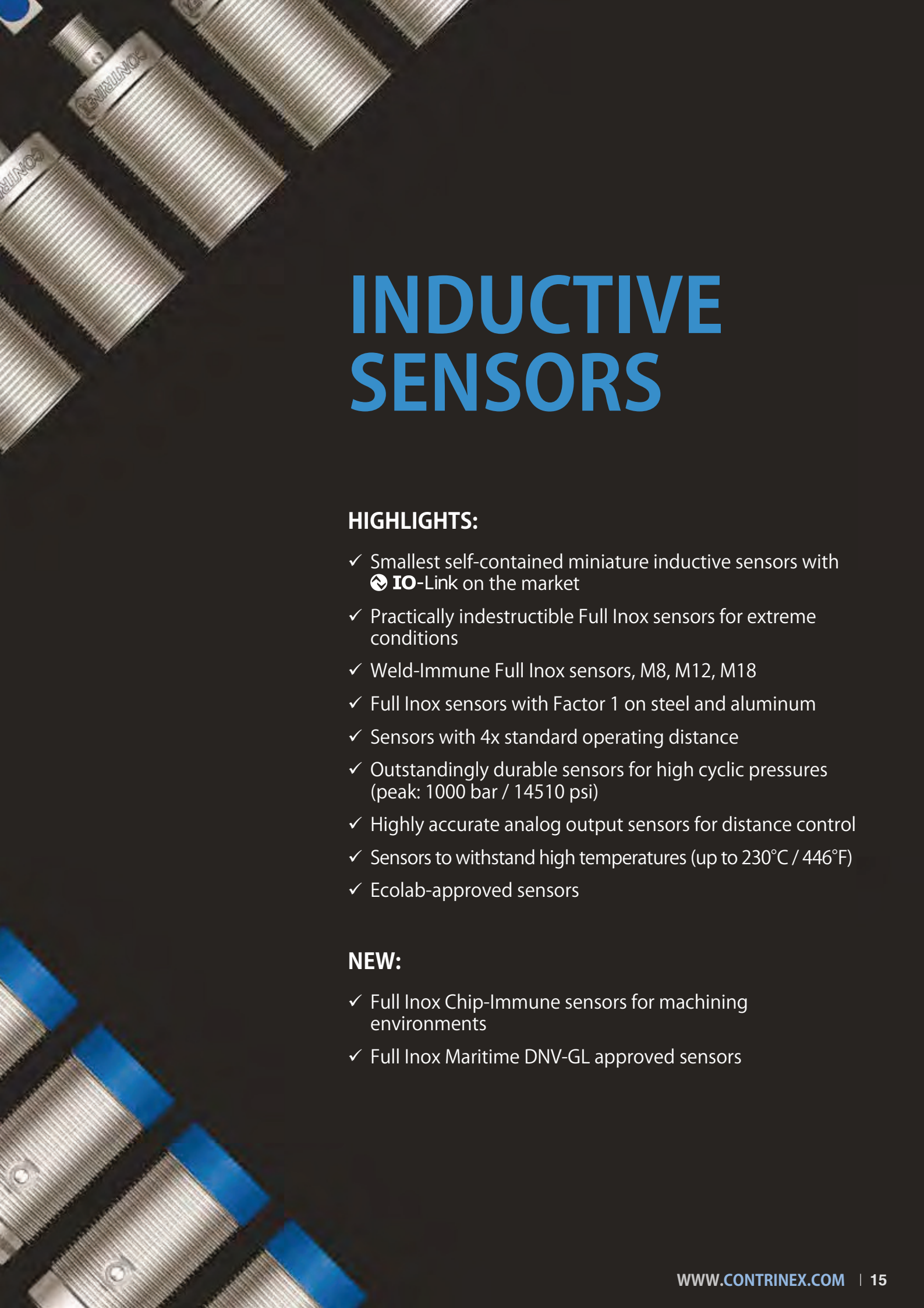

INDUCTIVE SENSORS



































HIGHLIGHTS:







- ✓ Smallest self-contained miniature inductive sensors with  IO-Link on the market
- ✓ Practically indestructible Full Inox sensors for extreme conditions
- ✓ Weld-Immune Full Inox sensors, M8, M12, M18
- ✓ Full Inox sensors with Factor 1 on steel and aluminum
- ✓ Sensors with 4x standard operating distance
- ✓ Outstandingly durable sensors for high cyclic pressures (peak: 1000 bar / 14510 psi)
- ✓ Highly accurate analog output sensors for distance control
- ✓ Sensors to withstand high temperatures (up to 230°C / 446°F)
- ✓ Ecolab-approved sensors

NEW:

- ✓ Full Inox Chip-Immune sensors for machining environments
- ✓ Full Inox Maritime DNV-GL approved sensors

PROGRAM OVERVIEW

FAMILY	HOUSING SIZE	OPERATING DISTANCE	BASIC	MINIATURE	EXTREME	ANALOG OUTPUT
			 IO-Link	 IO-Link	 IO-Link	
CLASSICS Series 600 1 x S _n / 2 x S _n	∅ 3	0.6 ... 1 mm		 p. 71-72		
	M4	0.6 ... 1 mm		 p. 72-73		
	∅ 4	0.8 ... 1.5 mm		 p. 73-75		
	M5	0.8 ... 1.5 mm		 p. 76-77		
	C5	0.8 ... 1.5 mm		 p. 78-79		
	∅ 6.5	1.5 ... 2 mm	 p. 31-35			
	M8	1.5 ... 4 mm	 p. 35-41, 43-44			
	C8	1.5 ... 2 mm	 p. 45-46			
	M12	2 ... 8 mm	 p. 47-51			
	M18	5 ... 8 mm	 p. 54-57			
	M30	10 ... 15 mm	 p. 60-61			
	M50	25 mm				
	40 x 40	15 ... 40 mm	 p. 66-67			
EXTRA DISTANCE Series 500 3 x S _n / 4 x S _n	∅ 4	2.5 mm		 p. 75		
	M5 / P5	1 ... 2.5 mm		 p. 77		
	∅ 6.5	2.5 ... 3 mm	 p. 35			
	M8 / P8	1.5 ... 6 mm	 p. 42-45			p. 95-96
	C8	2 ... 4 mm	 p. 46			p. 95
	M12 / P12	1.5 ... 10 mm	 p. 50-54			p. 96-97
	M18	12 ... 20 mm	 p. 57-59			p. 97-98
	M30	20 ... 40 mm	 p. 62-65			p. 98-99
	M14 / P20	3 mm				
FULL INOX Series 700 full-metal housing	∅ 4	3 mm		 p. 75		
	M5	3 mm		 p. 78		
	∅ 6.5					
	M8	3 ... 6 mm	 p. 41		 p. 83-84	
	M12 / P12	1.5 ... 15 mm	 p. 47-48		 p. 84-86	
	M18	5 ... 20 mm	 p. 55		 p. 87-88	
	M30	3 ... 40 mm	 p. 61		 p. 89-90	
	C23	7 mm			 p. 91	

	2-WIRE	EXTRA/HIGH PRESSURE up to 1000 bar peak  IO-Link	EXTRA TEMP. HIGH TEMP. -40 to +230°C  IO-Link	WELD-IMMUNE CHIP-IMMUNE DOUBLE-SHEET  IO-Link	MARITIME  IO-Link	WASHDOWN  IO-Link	Inductive
	p.103	 p.131					Photoelectric
	p. 103						
	p. 104	 p.131					
	p. 105	 p.131	 p.143				Safety
	p. 105						
	p. 106, 110						
	p. 107, 110-113		 p.143, 147				RFID
	p. 107, 114-119		 p.143, 147			 p.171	
	p. 108, 119-123		 p.143, 147-148				
	p. 109, 124-127		148-149				Connectivity
			p.149				
		 p.135					Accessories
		 p.131					
		 p.135					
		 p.135-137					Glossary
		 p.137-138					
							Index
				p.153			
		 p.137		 p.153, 157	 p.165	 p.171-172	
				 p.153, 157	 p.166	 p.172-173	
				 p.157, 161	 p.166-167	 p.173-174	
					 p.167		

PROGRAM OVERVIEW

MINIATURE + BASIC

HOUSING SIZE	OPERATING DISTANCE													PAGE
	5 mm	10 mm	15 mm	20 mm	25 mm	30 mm	35 mm	40 mm	45 mm	50 mm	55 mm	60 mm	65 mm	
∅ 3 mm / M4	0.6 mm													71 - 72
	1 mm													71 - 73
∅ 4 mm / M5	0.8 mm													73-74, 76
	1.5 mm													74 - 77
	2.5 mm													75, 77
	3 mm													75, 78
C5	0.8 mm													78
	1.5 mm													79
∅ 6.5 mm	1.5 mm													31 - 33
	2 mm													33 - 35
	3 mm													35
M8	1.5 mm													35 - 37
	2 mm													38 - 41
	2.5 mm													41
	3 mm													42
	4 mm													43 - 44
	6 mm												44 - 45	
C8	1.5 mm													45
	2 mm													45 - 46
	3 mm													46
M12	2 mm													47
	3 ... 4 mm													47 - 50
	6 mm													50 - 51
	8 mm													51 - 53
	10 mm												53 - 54	
M18	5 mm													54 - 55
	8 mm													55 - 57
	12 mm													57 - 58
	20 mm													59
M30	10 mm													60 - 61
	15 mm													61
	22 mm													62 - 63
	40 mm													64 - 65
C44	15 mm													66
	20 mm													66
	30 mm													67
	40 mm													67

OTHER RANGES

HOUSING SIZE	OPERATING DISTANCE													PAGE	Inductive
	5 mm	10 mm	15 mm	20 mm	25 mm	30 mm	35 mm	40 mm	45 mm	50 mm	55 mm	60 mm	65 mm		
EXTREME															
M8 / M12	2 ... 3 mm													83 - 84	Photoelectric
M8 / M12	6 mm													83 - 85	
M18 / C23	5 ... 7 mm													87, 91	
M12 / M18	10 mm													85 - 88	
M12	15 mm													86	
M18 / M30	20 mm													88 - 89	
M30	40 mm													90	
ANALOG OUTPUT															
C8 / M8	0 ... 4 mm													95 - 96	Safety
M12	0 ... 6 mm													96 - 97	
M18	0 ... 10 mm													97 - 98	
M18 / M30	0 ... 20 mm													98 - 99	
M30	0 ... 40 mm													99	
2-WIRE															
∅ 3 / ∅ 4 / M4 / M5 / C5	0.6 ... 0.8 mm													103 - 105	RFID
∅ 6.5	1.5 mm													106, 110	
M8	1.5 ... 2.5 mm													107, 110 - 113	
M12	2 ... 4 mm													107, 114 - 119	
M18	5 ... 8 mm													108, 119 - 123	
M30	10 ... 15 mm													109, 124 - 127	
EXTRA/HIGH PRESSURE															
∅ 3 / ∅ 4 / M5	0.6 ... 0.8 mm													131	Connectivity
∅ 6.5	2.5 mm													131	
M5 / P5	1 mm													135	
M8 / P8 / M12 / P12	1.5 ... 2.5 mm													135 - 137	
M14 / P20	3.0 mm													137 - 138	
EXTRA/HIGH TEMP.															
M5	0.8 mm													143	Accessories
M8	2 ... 4 mm													143, 147	
M12	2 ... 4 mm													143, 147	
M18	5 mm													143, 147-148	
M30	10 mm													148 - 149	
M50	25 mm													149	
WELD-IMMUNE CHIP-IMMUNE DOUBLE SHEET															
M8 / M12	3 ... 6 mm													153, 157	Glossary
M18	5 ... 10 mm													153, 157	
M30	12 mm													157	
M30	3 ... 5 mm													161	
MARITIME															
M12	1.5 mm													165	Index
M12	6 mm													165	
M18	10 mm													166	
M30	20 mm													166 - 167	
C23	7 mm													167	
WASHDOWN															
M12	2 mm													171	
M12	6 mm													171	
M12 / M18	10 mm													171 - 172	
M18 / M30	20 mm													173 - 174	
M30	40 mm													174	

INTRODUCTION

TECHNOLOGY

Contrinex inductive devices work according to one of **three different technologies**. All involve the generation of an alternating magnetic field that emerges at the sensing face. The presence of a conductive, generally metallic, object influences this field in a way that can be detected and evaluated by built-in electronics. All Contrinex ASIC sensors are IO-Link enabled in PNP NO versions.

TECHNOLOGY FAMILIES

CLASSICS FAMILY:

Conventional technology, engineered by Contrinex

The **Classics** family uses conventional inductive sensor technology, but with the benefit of a Contrinex ASIC (application specific integrated circuit). ASIC technology ensures reliability, stability and ease of commissioning, due to low variation. Sensors in this family achieve operating distances up to 2 x the industry standard. All ASIC sensors in the **Classics** family are IO-Link enabled in PNP NO versions.

Classics sensors have a conventional oscillator and coil generating a high-frequency magnetic field that emerges at the sensing face. Any metallic object found in this field absorbs some of the energy, which is in turn detected and evaluated by built-in electronics (Fig. 1).

Ferromagnetic metals (steel, nickel, cobalt) absorb the most energy. The achievable operating distances are therefore greatest with these metals. Non-ferromagnetic metals, such as aluminum, absorb less energy. As a result, operating distances are lower (approx. 25 ... 45% of those on steel).

The **Classics** technology family (series 600) includes devices from the ranges **Basic, Miniature Extra pressure, Extra temperature, High temperature, Wash-down, Weld-immune** and **2-Wire**.

EXTRA DISTANCE FAMILY:

Increased stability for exceptionally long operating distance

The **Extra Distance** family is based on the Condist® oscillator developed by Contrinex. Sensors benefit from **up to 4x the standard** operating distance, keeping them out of harm's way in rugged, industrial environments. Sensor lifetime is therefore increased.

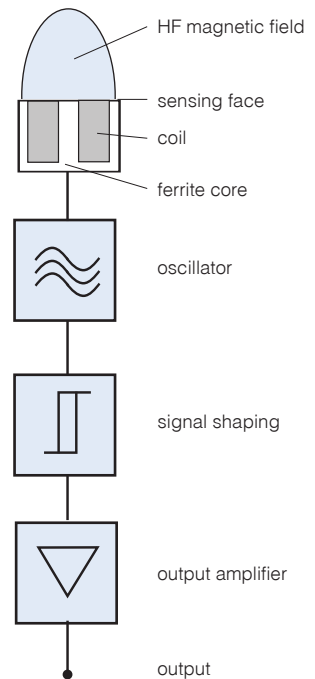

Fig. 1: Conventional inductive sensor technology, as used in the **Classics** family

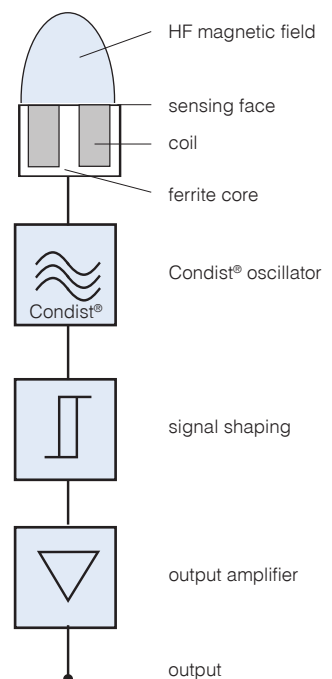

Fig. 2: Contrinex's Condist® inductive sensor technology, as used in the **Extra Distance** family

Like **Classics** family sensors, these also generate a high-frequency magnetic field that emerges at the sensing face (Fig. 2). Again, the resulting effect is that any metallic object entering the field absorbs energy from it.

However, the oscillator and the subsequent signal evaluation circuit are completely different, with the objective of achieving a significantly **better stability** with respect to environmental influences, in particular temperature. The most important contribution to this comes from the Contrinex Condist® oscillator.

Improved stability permits the switch point to be further away, leading to **long operating distances** on ferromagnetic metals (Fig. 3). Sensors with this technology also react particularly well to **narrow targets**, e.g. small screws, wires and foils.

Apart from the Condist® oscillator, all other assemblies are equivalent to the **Classics** family. Material dependencies and other properties are also the same as for **Classics** family sensors.

Special attention has been paid to **meet the relevant standards as much as possible**, so that easy **interchangeability** with conventional devices is guaranteed. Great emphasis has been placed on very good EMC resistance and on perfect sealing against liquid penetration.

The **Extra Distance** technology family includes devices from the **Basic, Miniature, Extra pressure, High pressure** and **Analog output** ranges. This technology is used in series 500 devices.

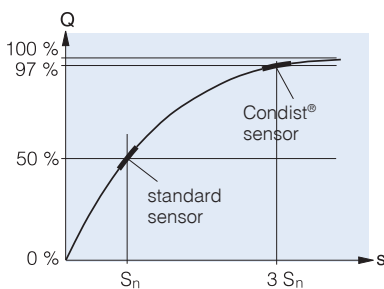

Fig. 3: **Extra Distance** family sensors have a longer operating distance, due to Condist® oscillator technology

FULL INOX FAMILY:

All-round stainless steel protection - practically indestructible

The **Full Inox** family is based on Contrinex's patented Condect® technology. These one-piece stainless steel sensors are not only the most durable on the market, they also offer long operating distances on any conductive metal.

Full Inox sensors also function according to inductive technology. However, the coil which generates the magnetic field is not part of the oscillator (Fig. 4). Instead, the field is generated by periodic, short **transmitter current pulses**, which flow through the coil (Fig. 5). This field induces a voltage in the target which, in turn, generates a current flow in it. When the transmitter current pulse is switched off, the current in the object dies away, causing a **voltage to be induced** in the transmitting coil (Fig. 6).

This voltage generates the signal required, and is in principle **independent of the field's energy loss**. Therein lies the fundamental advantage of this technology, since the field energy losses, which are evaluated in conventional sensors, are subject to a number of undesirable environmental and material influences.

Condect® technology allows the sensor, including its face, to be fully encapsulated in a protective, stainless steel housing, with the added security of long operating distances.

The coupling between the target and the coil is rather **like a transformer**, and is hence **temperature independent** and only **slightly influenced by the target's material**. Operating distances are therefore identical on steel and aluminum. Only metals which are non-ferromagnetic and also have poor electrical conductivity give a reduced usable signal.

The **Full Inox** family includes devices from the **Basic, Miniature, Extreme, High Pressure, Washdown, Weld-Immune, Chip-Immune, Maritime** and **Double-Sheet** ranges.

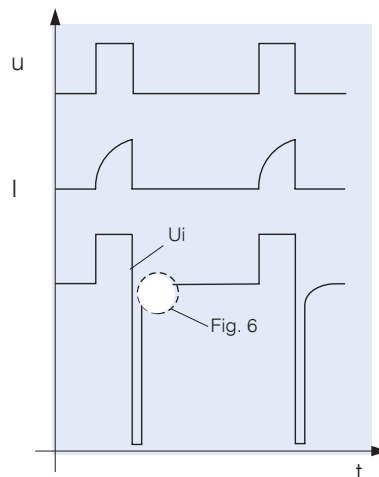

Fig. 5: Evolution of main signals

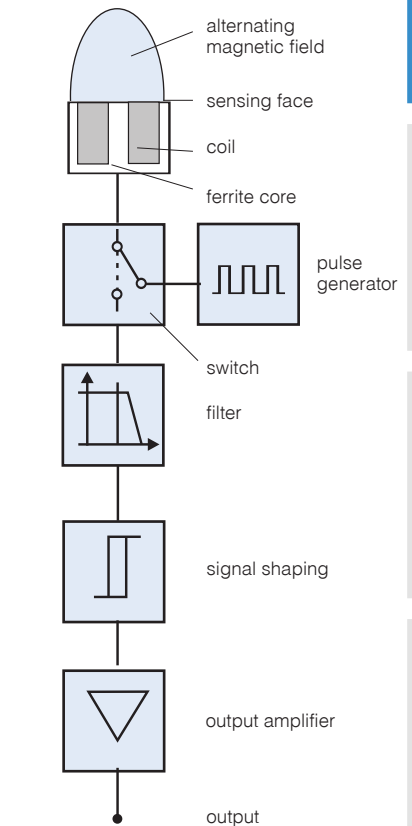

Fig. 4: **Full Inox** family sensors use Condect® pulse generator technology instead of an oscillator

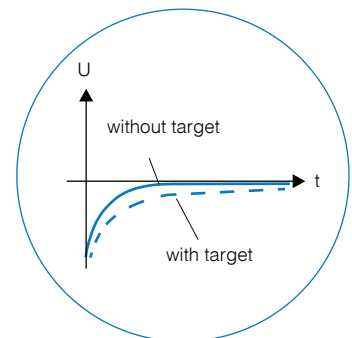

Fig. 6 (detail fig. 5): Effect of a target on the measured signal

INTRODUCTION

PRODUCT RANGES

BASIC

First choice in all environments

Contrinex **Basic** range inductive sensors have a worldwide and well-deserved reputation for uncompromising accuracy and exceptional reliability. With best-in-class sensing distances between **1.5 mm** and **40 mm**, the **Basic** range offers fit-and-forget operation, delivering world-class performance and a highly attractive total cost of ownership.

Available in sizes from M8 to M30 and C44, with optional Ø 6.5 plain and 8 mm square-section models, **Basic** range inductive sensors are ideal for general position-sensing and presence-sensing applications in almost any industry. Embeddable or non-embeddable variants are available, with either hard-wired, hermetically sealed connecting cables or integral metal connectors. **Basic** range devices, whether from the **Classics** (Fig. 1), **Extra Distance** (Fig. 2) or **Full Inox** (Fig. 4) technology families, all utilize Contrinex application-specific integrated circuits (ASICs) that ensure highly repeatable results at operating temperatures between -25°C and +70°C. An **IO-Link** interface is also available for communication in PNP NO versions.



MINIATURE

Full functionality, smallest size

Size is often a critical constraint when selecting sensors for position- or presence-sensing. The Contrinex **Miniature** range, which includes the smallest self-contained inductive sensors on the market, meets this constraint without compromising on functionality.

Sensors from this range use either **Classics** (Fig. 1), **Extra Distance** (Fig. 2) or **Full Inox** (Fig. 4) technology. Available in plain and threaded sizes from Ø 3 to M5 and as a 5 mm square-section type, **Miniature** range inductive sensors are ideal for applications where space is limited, including tool-selection, robotic position-sensing and control of micro-mechanisms.

Extremely robust, thanks to chip-scale package (CSP) technology, a glass-fiber reinforced substrate and vacuum encapsulation, the Contrinex **Miniature** range delivers long-term reliability and maximum uptime, even in the most demanding environments. The low mass and **high switching frequency** of these sensors makes them particularly suitable for high-dynamic applications where inertia is a major consideration.

These embeddable devices are available in 3-wire DC, NPN and PNP versions with a choice of NO or NC configurations. An LED output state indicator is standard. All the important protection functions are included, such as short-circuit and overload protection, full polarity reversal protection, induction protection, EMC protection, power-on reset, etc.

With a sensing range up to **3 mm**, Contrinex miniature inductive sensors combine world-class quality with a highly attractive total cost of ownership. An **IO-Link** interface is also available for communication in PNP NO versions.



EXTREME

Extreme durability in harsh environments

Only the toughest sensors survive the most extreme environments, and **Extreme** range inductive sensors from the **Full Inox** family are ideally equipped for the job. Thanks to one-piece stainless-steel (V2A/AISI 303) construction and a hermetically sealed cable entry, **Extreme** sensors are corrosion-resistant, impervious to oil, and pressure-resistant to **100 bar**. Rugged, reliable and highly accurate, the **Extreme** range is at home in the most challenging circumstances.



Developed to withstand the harshest industrial operating conditions, **Extreme** sensors are rated to **IP 68** and **IP 69K**, delivering fit-and-forget performance with minimal downtime. With operating distances up to **40 mm**, the **Extreme** range senses both ferrous and non-ferrous materials with **Factor 1** performance, and is available in sizes from M8 to M30 and C23. An **IO-Link** interface is also available for communication in PNP NO versions.

ANALOG OUTPUT

Continuous analog output for precision control

Engineers needing a reliable, repeatable, highly accurate means of measuring the position of a target object should look no further than Contrinex **Analog output** inductive sensors. This range of sensors has been developed on the platform of **Extra Distance** (Fig. 2) technology for excellent temperature stability, repeat accuracy, and the best long-range sensing capability on the market. With a measurement range of **zero to 40 mm** and detection accuracy on the micron scale, the **Analog output** sensor range is ideally suited for measuring linear, angular and rotational position (Fig. 7). They offer world-class performance and an attractive total cost of ownership in applications from vibration monitoring and end-position approach regulation, to position monitoring, metal sorting and sheet-metal forming.

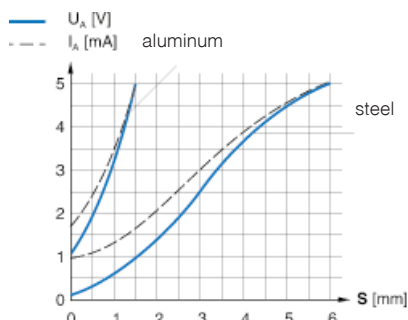

Fig. 7

Analog output inductive sensors are available in sizes from M8 to M30, with the option of an 8 mm square-section model. Voltage outputs are included for all sizes, while sizes M12 and above feature both voltage and current outputs.

2-WIRE

Easy installation and high switching frequency

The **2-Wire** range of DC, AC/DC and NAMUR sensors is constructed on the **Classics** (Fig. 1) technology platform and includes sizes from $\text{Ø} 3$ to M30, plus a 5 x 5 mm square-section type.



Devices are available for embeddable or non-embeddable mounting and connection is by means of cable or connector. With a sensing range up to 15 mm, Contrinex **2-Wire** sensors ensure optimal equipment utilization.

EXTRA PRESSURE

Pressure resistant up to 200 bar

Dependable, accurate presence- and position-sensing at pressures up to **200 bar** requires world-class performance and build quality. The **Extra pressure** range of pressure-resistant inductive sensors delivers exactly that, operating continuously in permanently pressurized conditions. This makes the range especially suitable for offshore installations, the chemical industry, motor lubrication systems and atomic fuel element monitoring. A stainless-steel housing with bonded ceramic or brazed sapphire sensing face and protection class **IP 68** guarantees robustness and exceptional reliability in miniature packages sized from $\text{Ø} 3$ to M6.5.

The **Extra pressure** range is also ideal for high-vacuum environments and satellite applications, offering fit-and-forget capability and a sealed cable-entry that ensures no loss of service or interruptions to production.

Sensors from this range use either **Classics** (Fig. 1) or **Extra Distance** (Fig. 2) technology and have equivalent electrical properties. For optimum impermeability, LED and connector versions are not available in this range.

Sensors from the **Extra pressure** range detect parts at sensing distances up to **2.5 mm**, and offer a highly attractive total cost of ownership. An **IO-Link** interface is also available for communication in PNP NO versions.



HIGH PRESSURE

Resistant to pressure and dynamic stress up to 500 bar (peak 1000 bar)

For reliable, accurate sensing in the most demanding pneumatic and hydraulic applications, Contrinex offers a unique range of **High pressure** sensors with permanent operating pressures of **100 ... 500 bar** and peak pressures up to **1000 bar**.

Suitable for operating temperatures up to 100°C and resistant to more than 1 million pressure cycles, their IP 68 and IP 69K protection and oil impermeability make them the robust, reliable choice for the hydraulic industry. Fit-and-forget operation virtually eliminates sensor replacement costs. Exceptional performance and world-class quality are assured in sizes from M5 to M18.



INTRODUCTION

Contrinex **High pressure** sensors are available in either **Extra Distance** (Fig. 2) or **Full Inox** (Fig 4) versions. Both of these technologies ensure durability without compromising on usable operating distance. Sensor construction is simple and robust, with the whole electronic unit, ferrite core and coil included, safely on the **no-pressure side**. Sealed connection is by means of either flexible PU cable or an integral connector.

Fig. 8 shows an **Extra Distance** version. The stainless steel housing is heat shrunk onto the ceramic disk, making the sensor mechanically resistant, **exceptionally impervious**, and outstanding for applications with **high dynamic pressure stress**, such as piston-control applications. With operating distances of up to 3 mm, they are gas-tight and meet protection class **IP 68**.

Versions from the **Full Inox** family have a practically indestructible pressure- and corrosion-resistant one-piece stainless steel housing (V4A / AISI 316L / DIN 1.4404). They provide excellent detection of all metals with good conductivity, both ferromagnetic and non-ferromagnetic. These corrosion resistant sensors are suitable for the harshest conditions and meet protection classes **IP 68 & IP 69K**. An **IO-Link** interface is also available for communication in PNP NO versions.

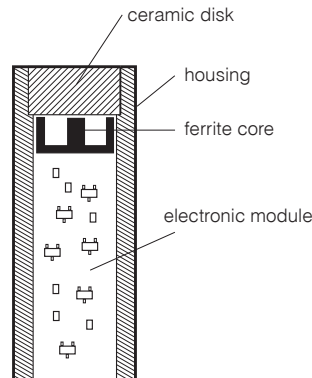

Fig. 8

HIGH TEMPERATURE

Temperature resistant up to 180°C (230°C with external amplifier)

Contrinex **High temperature** inductive sensors are designed for continuous operation at temperatures from 0°C up to 180°C (up to 230°C with remote electronics). The range is ideal for the harshest environments, including automotive paint shops, metal-treatment plants and glass manufacturing.



EXTRA TEMPERATURE

Temperature resistant up to 120°C

Inductive sensors from the **Extra temperature** range offer the ideal solution for position- and presence-sensing applications at temperatures from as low as minus 40°C up to 120°C. Industrial processes often generate heat, resulting in temperatures that would damage a standard sensor, but the stainless-steel construction and robust electronics of Contrinex **Extra temperature** sensors ensure reliable, accurate operation and minimal downtime, even in the most demanding environments.

Sensors from this range use either conventional **Classics** (Fig. 1) or all-metal **Full Inox** (Fig. 4) technology. Individually compensated for repeatable, highly accurate operation across the full operating temperature range, **Extra temperature** inductive sensors accommodate sensing distances up to 25 mm, minimizing the risk of collision damage.

Available in sizes from M5 to M18, the **Extra temperature** range delivers best-in-class performance at elevated temperatures in the harsh environments of the automotive, molding and metal-processing industries. An **IO-Link** interface is also available for communication in PNP NO versions.



High temperature sensors use **Classics** (Fig. 1) technology. Embeddable and quasi-embeddable versions are available. For temperatures up to 180°C, sensors feature built-in amplifiers and include highly durable 100% silicone-free types. Connection is by means of an FEP, Teflon or silicone cable. For 230°C types, the amplifiers are built into an M12 stainless-steel housing, which is connected by means of a standard 3 m Teflon cable, and thus removed from the hot area. Stainless steel construction and sensing distances up to 25 mm minimize the risk of mechanical damage during operation, ensuring maximum plant availability and a highly attractive total cost of ownership. Contrinex **High temperature** sensors are available in sizes from M8 to M50.

WELD-IMMUNE

Immune to magnetic fields and resistant to weld spatter

Contrinex **Weld-immune** inductive sensors are ideal for the hostile working environments found in automotive factories and other industrial welding plants. The range includes sensors from two technology platforms: **Classics** (Fig. 1) and **Full Inox** (Fig. 4).

Classics devices, with protection class IP 67, are available either in PTFE-coated cylindrical brass housings or a PBTP 40 x 40 mm cubic form. They resist solder and the strong magnetic fields present during industrial welding processes. They have identical operating distances on steel and non-ferrous metals.

Weld-immune sensors built on the **Full Inox** platform have a long operating distance and Factor 1 on steel and aluminum. One-piece, stainless-steel (V2A / AISI 303) construction makes these sensors the most durable on the market, ensuring minimal down-time. These practically indestructible sensors withstand the welding environment for years, resisting electromagnetic fields, welding spatter, cleaning and impacts.

All **Weld-immune** sensors are embeddable and have an integral S12 connector. Best-in-class sensing ranges of up to **15 mm** eliminate the risk of collision - a frequent hazard when operating in close proximity to moving machine parts.

Developed for extreme accuracy throughout the welding cycle, **Weld-immune** sensors continuously detect part presence and machine position to ensure optimal equipment utilization and prevent errors in production. These sensors provide excellent repeatability at temperatures between -25°C and +70°C.



DOUBLE-SHEET

Detection of double-sheets in metalworking

For double-sheet detection, sensors from the **Full Inox** (Fig. 4) family are used. Its patented inductive technology enables discrimination between one and two conductive metal sheets of a defined thickness, achieving sensitivity of 0.8 - 1.2 mm per sheet. This discrimination aids in the prevention of double feeds into blanking and forming processes which ultimately saves damage to tooling. The one-piece, stainless-steel construction of these sensors makes them the most durable on the market. They withstand the impacts that are a common hazard in double-sheet detection applications close to moving sheet metal, ensuring minimal down-time.



CHIP-IMMUNE

For the harshest machining environments

Even when covered with chips of steel, stainless steel, aluminum, brass, copper or titanium, **Chip-Immune** inductive sensors from the **Full Inox** technology family will reliably detect targets made of these metals. The sensors achieve this with a slightly modified form of Condet® technology. In a one-piece stainless steel housing with **IP 68/IP 69K** protection rating and a wide operating temperature range from -25 to +85°C (-13 to +185°F), they are particularly suitable for use in the harsh environments of the machining industry. Depending on sensor diameter (**M12**, **M18** or **M30**), operating distances of 3, 5 or 12 mm are available. In the PNP version, sensors also include an **IO-Link** interface for point-to-point communication with the controller of the system.



INTRODUCTION

MARITIME

DNV-GL approved for ships, ports and offshore

The **Maritime** range of embeddable inductive sensors, certified by Germanischer Lloyd, offers unrivalled performance features based on **Full Inox** technology (Fig. 4). With a one-piece housing in V4A/AISI 316L stainless steel and an enclosure rating of **IP 68/IP 69K**, they are not only impervious, but also corrosion-proof and resistant to salt water. Their EMC protection also meets specific maritime requirements, particularly with regard to power supply variations and low frequency immunity. They offer the longest service life of any inductive sensor on the market, even in the harshest marine environments. The maximum operating pressure is 80 bar or 500 bar (peak 800 bar) for P12G high-pressure types. Depending on sensor size (**M12, C23, M18** or **M30**), operating distances of 6, 7, 10 or 20 mm are available. In the PNP version, sensors also include an **IO-Link** interface for point-to-point communication with the controller of the system. The range also includes **M10** types with **Classics** technology.



Conversion of temperature	
Celsius	Fahrenheit
-40	-40
-25	-13
0	+32
+70	+158
+85	+185
+100	+212
+120	+248
+180	+356
+230	+446

Conversion of pressure	
Bar	PSI
1	14.5
80	1160
100	1451
200	2901
500	7255
800	11603
1000	14510

WASHDOWN

Ecolab approved for strictest production hygiene

Washdown inductive sensors are certified to operate continuously and reliably in the harsh conditions of the food, beverage and pharmaceutical industries, ensuring uninterrupted production. With **Ecolab** approval and rated to **IP 68** and **IP 69K**, they are pressure resistant up to **80 bar**, **food safe** and **corrosion resistant**.

Washdown sensors are available in conventional **Classics** (Fig. 1) technology, size M12, or **Full Inox** (Fig. 4) technology, sizes M12, M18 and M30. **Full Inox** types have a totally impervious one-piece housing in stainless-steel (V4A / AISI 316L), including the sensing face. They are therefore highly resistant to the corrosive chemicals used for clean-in-place or wash-down processes. With Factor 1 on steel and aluminum and extended sensing ranges up to 40 mm, **Full Inox** technology minimizes the possibility of impact damage - a common hazard in confined operating spaces.

Washdown sensors meet the increasingly demanding sensing needs of the food, beverage and pharmaceutical industries, delivering best-in-class performance with an attractive total cost of ownership. An **IO-Link** interface is also available for communication in PNP NO versions.



IO-LINK FUNCTIONALITY* WITH INDUCTIVE SENSORS (PNP N.O. TYPES)

Data monitoring:

- 1 Switching state is monitored continuously. This not only monitors the signal itself, but also the state at 80% of the switching distance. One can therefore ensure that the sensor is not working at the limit of its specifications.

Diagnosis:

- 2 The operating state of the sensor is checked. In case of wire break, under-voltage, LC oscillator break or installation of the wrong sensor, information is provided directly through IO-Link to enable fast repair, maintenance and replacement.

NO/NC selection:

- 3 The output switching mode can be selected as NO or NC. A single sensor type is configurable for the various needs of an application. This helps reduce the number of different sensor types required in stock.

Switching timer:

- 4 The timing of output switching can be configured. Depending on the needs of an application, output switching can be delayed or the duration stretched through programming.

Detection counter:

- 5 Detection events are counted. By registering the number of detections, it is possible to calculate the speed or number of parts. The counter can be reset by means of a unique IO-Link message.

Temperature:

- 6 The internal temperature of the sensor is measured continuously, which provides an indication about the ambient temperature in the application. Moreover, the maximum temperature measured is saved for diagnosis and preventive maintenance purposes.

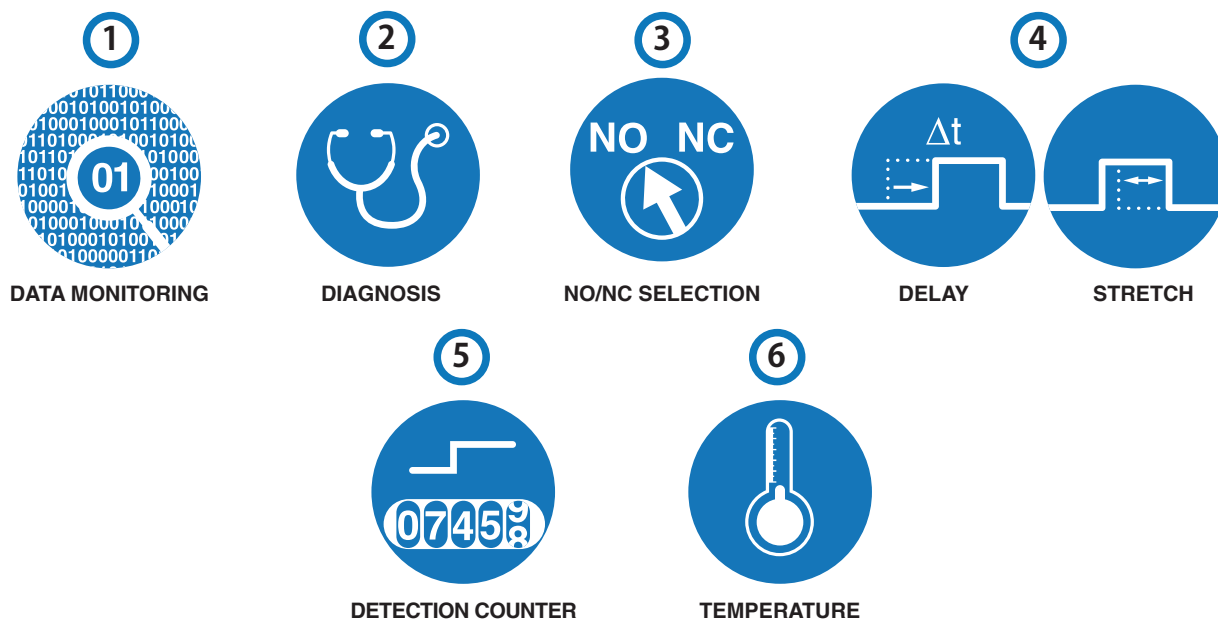

* Functionalities may vary depending on series and sensor type



GLOSSARY

HIGHLIGHTS:

- ✓ Clearance
- ✓ Connectors
- ✓ Correction factors
- ✓ Degrees of protection
- ✓ EMC
- ✓ Excess gain
- ✓ Hysteresis
- ✓ Mounting
- ✓ Oil resistance
- ✓ Operating distance
- ✓ Parallel connection
- ✓ Switching frequency
- ✓ Tightening torque
- ✓ Turn-on/turn-off time



 **INDUCTIVE SENSORS**

 **PHOTOELECTRIC SENSORS**

A

ADJUSTMENT (POTENTIOMETER)



The sensitivity is adjusted by means of the built-in single or multi-turn potentiometer (if provided). Turning it clockwise increases the sensitivity. Multi-turn potentiometers cannot be turned over their end position (no stops).

THROUGH-BEAM SENSORS / REFLEX SENSORS

The potentiometer is normally set to the maximum sensitivity (turned clockwise). This provides the maximum system reserve (excess-gain) signal.

DIFFUSE SENSORS

Set the sensitivity so that the target is reliably detected; for reliable operation, the green LED should light up, or the yellow LED should not flash (series 1040/1050/0507). On removing the object, if the output remains ON (detection of the background), the sensitivity must be reduced slightly.

DIFFUSE SENSORS WITH BACKGROUND SUPPRESSION

The setup must ensure that the target is clearly identified, and any background excluded. The target should first be positioned at the maximum foreseen distance from the emitter, and the potentiometer adjusted so that the output just switches. The target is then removed and the potentiometer adjusted so that the background just causes the output to switch. Finally, the potentiometer is set to half way between the two previous readings. Where there is no background, the potentiometer should be set to the maximum distance.

ALIGNMENT



THROUGH-BEAM SENSORS

First place the receiver and fix it in its final position. Then align the emitter accurately onto the receiver.

REFLEX SENSORS

First place the reflector as required and fix it firmly in position. Fit the reflex sensor with the optical axis aligned on the reflector so that it switches reliably. Test with target. Reduce sensitivity if necessary.

DIFFUSE SENSORS

Align the unit's optical axis with the target so that switching occurs reliably. Check that enough system reserves (excess gain) are available, i.e. the green LED must light up (series 1120, 1180, 1180W, 3030, 3031, 3060, 4040, 4050 and C23). Finally, fix the device firmly.

DIFFUSE SENSORS WITH BACKGROUND SUPPRESSION

Line up the beam on the center of the target, before fixing the device firmly.

AMBIENT LIGHT LIMIT



Ambient light is that which is produced by external light sources. The illumination intensity is measured on the light incidence surface. The sensors are basically insensitive to ambient light due to the use of modulated light. There is nevertheless an upper limit for the intensity of any external light and this is referred to as the ambient light limit. It is given for sunlight (unmodulated light) and halogen lamps (light modulated at twice the mains frequency). Reliable operation of the units is no longer possible at light intensities above the relevant ambient light limit.

AMBIENT TEMPERATURE



The specified ambient temperature range **must not be exceeded** in order to avoid damaging the sensor and rendering its performance unreliable.

ANALOG OUTPUT



Devices with analog output deliver an analog output signal approximately proportional to the target distance. For most models, voltage and current outputs are available **simultaneously**.

AUTOCOLLIMATION



Photoelectric sensors using the autocollimation principle are characterized by the fact that the optical axes of the emitting and receiving channels are identical. This is possible with light from one of the channels being deflected by means of a semi-transparent mirror (Fig. 13). This principle completely eliminates the interfering blind zone often found in the proximity of the sensor, which is of special advantage when using reflex sensors.

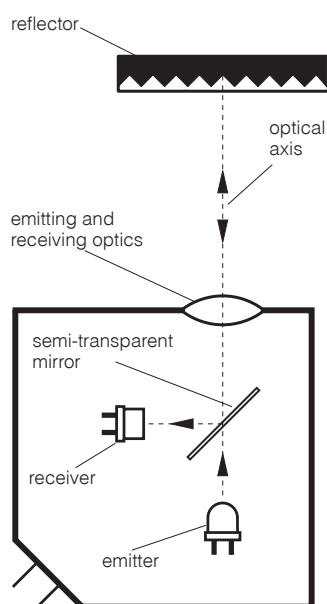

Fig. 13

B

BACKGROUND SUPPRESSION



The light pulse from the emitting diode leaves the optical system as a focused, almost parallel, light beam. On meeting an object in its path, part of the beam is diffusely reflected, and in turn, part of this reflected light falls on the PSD (**P**osition-**S**ensitive **D**evice) housed in the same sensor (Fig. 14).

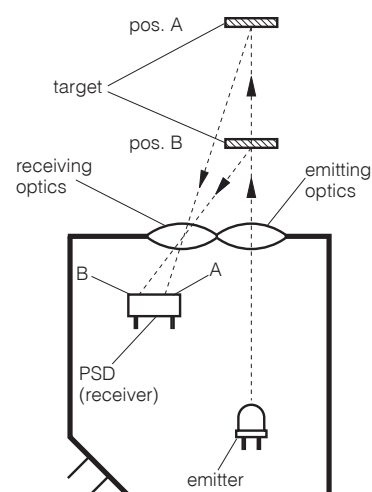

Fig. 14

Depending on the distance of the target from the device, the light falls on a particular spot of the PSD, and a corresponding reception signal is emitted, indicating that an object is present at a certain distance from the device. The analyzing circuit compares the signal received with the preset operating distance (adjusted by means of the built-in potentiometer), and, if the distance of the object is less than, or equal to, the preset operating distance, the output is switched. Contrary to an energetic diffuse sensor, the operating distance depends only to a very small extent on the target's size or color, or on the nature of its surface. The object can therefore be easily discerned, even against a light background.

C

CAPACITANCE



The maximum switchable capacitance is the greatest permissible total capacitance at the device's output so that **reliable switching** is still guaranteed. Contributing to this total capacitance in particular are the lead capacitance (approx. 100 ... 200 pF per m) and the load's input capacitance. The value is given in the individual data sheets. These can be found on the Contrinex website (www.contrinex.com), or ordered from our sales offices.

CE MARK



All sensors in this catalog meet the requirements of European standards EN 60947-1 and EN 60947-5-2, and therefore correspond to EMC directive 2004/108/EC, as well as low-voltage directive 2006/95/EC. Consequently, they are labeled with the CE mark.

CE

However, this mark is **neither a quality seal, nor an official test label** certified by any authority. By applying the CE mark, the manufacturer confirms (under his own responsibility) that the protective requirements for the product meet the applicable EU directives, and consequently that the corresponding EU standards have been complied with. The CE mark enables the free importation of goods into the EU, as well as their free circulation within the EU.

CHANGEOVER



Devices with changeover outputs provide one output for the light-ON or NO signal, and another for the dark-ON or NC signal. Both functions are available simultaneously for maximum connection flexibility to the control unit. Moreover, logical connections may be implemented without using series connection. Connecting both outputs to the control unit allows additional security monitoring.

CLASSICS FAMILY



The **Classics** family (600 series) is one of three inductive sensing technologies offered by Contrinex. **Classics** family sensors rely on conventional inductive oscillator and coil technology (see page 20).

Sensors are sized from Ø 3 up to M30 and C44 (40 mm x 40 mm). PNP, NPN and 2-wire AC/DC output configurations are available, combined with sensing distances between 0.6 mm and 40 mm.

The **Classics** technology family includes devices from the following ranges: **Basic**, **Miniature**, **2-wire**, **Extra pressure**, **Extra temperature**, **High temperature** and **Washdown**.

CLEARANCE



Inductive sensors must not mutually influence each other. For this reason, a minimum distance **A** between devices of diameter **D** must be observed (Fig. 15).

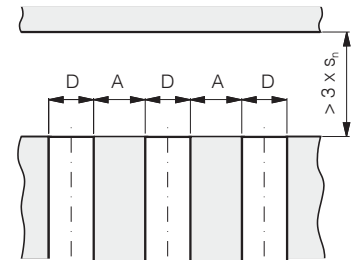

Fig. 15

EXTRA DISTANCE (SERIES 500, 520*)

Size D	(quasi)-embed. A (mm)	non-emb. A (mm)
Ø 4	6 (embeddable)	---
M5	5 (embeddable)	---
Ø 6.5	9.5	---
M8	8 / *16	20
C8	8	---
M12	18 / *34	30
M18	26	60
M30	50	120

CLASSICS (SERIES 600, 620*)

Size D	embeddable A (mm)	non-emb. A (mm)
Ø 3	0 / *2	---
M4	0 / *1	---
Ø 4	0 / *1	---
M5	0 / *1	---
C 5	0 / *1	---
Ø 6.5	3 / *3.5	--- / *15.5
M8	2 / *4	10 / *14
C8	2 / *2	---
M12	4 / *12	28 / *33
M18	7 / *22	32
M30	10	50
C44	35	120

DIFFUSE SENSORS (FIG. 16)

Series	distance a (mm)
Series 1040 / 50	50
Series 1040 / 50...505	15
Series 1040 / 50...506	30
Series 1120	150
Series 1180 / 1180W	500
Series 3030	500
Series 3031	250
Series 4050	150

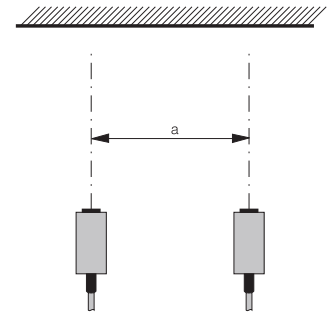

Fig. 16

FULL INOX (SERIES 700)

Size D	embeddable A (mm)	non-emb. A (mm)
M8	14	52
M12	38	108
M18	42	182
M30	80	270



Photoelectric sensors must not mutually influence each other. For this reason, a minimum distance “a” between them has to be respected, which depends strongly on the model used and the actual sensitivity setting. The following values should therefore be considered as rough guidelines only. The values given are for maximum sensitivity.

DIFFUSE SENSORS WITH BACKGROUND SUPPRESSION

Series	distance a (mm)
Series 1180 / 1180W	50
Series 3130	50
Series 3131	50
Series 4050	100

REFLEX SENSORS (FIG. 17)

Series	distance a (mm)
Series 1120	150
Series 1180 / 1180W	250
Series 3030	500
Series 3031	250
Series 4050	200

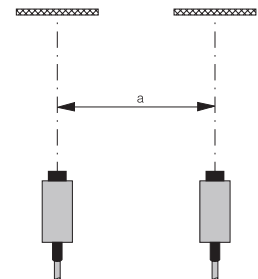

Fig. 17

THROUGH-BEAM SENSORS (FIG. 18)

Series	distance a (mm)
Series 1040 / 50	50
Series 1120	150
Series 1180 / 1180W	250
Series 3030	500
Series 3031	250
Series 4050	500

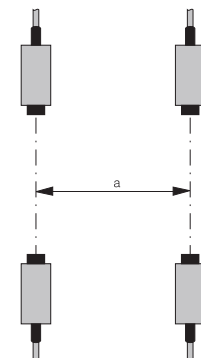

Fig. 18

FIBER-OPTIC AMPLIFIERS

The value “a” depends strongly on the specific type of fiber used. General recommendations are therefore not possible.

CONDET® TECHNOLOGY



An innovative technology for producing inductive sensors. Contrary to conventional technology, in which a high-frequency magnetic field is generated in front of the sensing face, here the coil is triggered by an alternating polarity **pulsed current**. This technology is used in the Full Inox family (700 series) (see also page 20). It permits:

- generally long operating distances
- long operating distances also on non-ferrous metals, such as aluminum, brass, copper, etc.
- **one-piece** stainless steel housing (sensing face included)

CONDIST® TECHNOLOGY



Developed by Contrinex, this innovative technology makes use of a high-performance oscillator for inductive sensors. Operating distances from **2.2 to 4 times** the standard values are possible thanks to excellent temperature and voltage stability. Devices of the Extra distance family (500 and 520 series) work with such an oscillator (see also page 21).

CONNECTORS



PIN ASSIGNMENT SIZE S8:

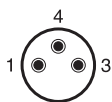

NO and NC

+U _B	pin 1	brown
0V	pin 3	blue
output	pin 4	black

NAMUR

L+	pin 1	brown
L-	pin 4	blue

Analog output

+U _B	pin 1	brown
0V	pin 3	blue
voltage output	pin 4	black

PIN ASSIGNMENT SIZE S12:

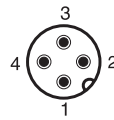

NO

+U _B	pin 1	brown
0V	pin 3	blue
output	pin 4	black

NC

+U _B	pin 1	brown
0V	pin 3	blue
output	pin 2	white

2-wire DC / NO

L-	pin 3	brown
L+	pin 4	blue

2-wire DC / NC

L-	pin 1	brown
L+	pin 2	blue

Analog output

+U _B	pin 1	brown
0V	pin 3	blue
voltage output	pin 4	black
current output	pin 2	white

PIN ASSIGNMENT SIZE 1/2":



2-wire AC/DC / NO and NC

L1	pin 3	blue
L2	pin 2	brown
GND	pin 1	yellow/green



PIN ASSIGNMENT SIZE S8 3 POLE:

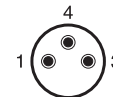

NO and NC

+U _B	pin 1	brown
0V	pin 3	blue
output	pin 4	black

PIN ASSIGNMENT SIZE S12 3 POLE:

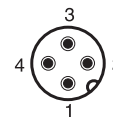

NO

+U _B	pin 1	brown
0V	pin 3	blue
output	pin 4	black

NC

+U _B	pin 1	brown
0V	pin 3	blue
output	pin 2	white

PIN ASSIGNMENT SIZE S12 5 POLE:

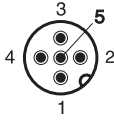

NO and NC

+U _B	pin 1	brown
output 2	pin 2	white
OV	pin 3	blue
output 1	pin 4	black
test	pin 5	gray

PIN ASSIGNMENT SIZE S8 4 POLE:



NO and NC

+U _B	pin 1	brown
output 2	pin 2	white
OV	pin 3	blue
output 1	pin 4	black

Teach

+U _B	pin 1	brown
output 2	pin 2	white
OV	pin 3	blue
output 1	pin 4	black

PIN ASSIGNMENT SIZE S12 4 POLE:

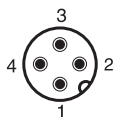

NO and NC

+U _B	pin 1	brown
output 2	pin 2	white
OV	pin 3	blue
output 1	pin 4	black

CORRECTION FACTORS



The specified operating distance **s** of inductive sensors refers to exactly defined measuring conditions (see **OPERATING DISTANCE**).

Other arrangements generally result in a reduction of the operating distance. The following data are to be considered as **guidelines** only; according to size and version, there can be wide variations. Exact values are given in the individual data sheets. These can be found on the Contrinex website (www.contrinex.com), or ordered directly from our sales offices.

CLASSICS (SERIES 600 / 620)

Material influence (indicative values):

Target material	Operating distance
Steel type FE 360	$s_n \times 1.00$
Aluminum	$s_n \times 0.55$
Brass	$s_n \times 0.64$
Copper	$s_n \times 0.51$
Stainless steel (V2A)	$s_n \times 0.85$

Geometrical influence:

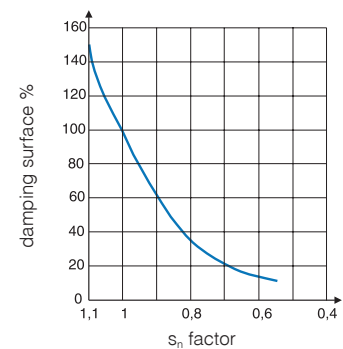

When using foils, an increase in the usable operating distance can be expected.

EXTRA DISTANCE (SERIES 500 / 520*)

Material influence (indicative values):

Target material	Operating distance
Steel type FE 360	$s_n \times 1.00$
Aluminum	$s_n \times 0.36 / *0.28$
Brass	$s_n \times 0.44 / *0.37$
Copper	$s_n \times 0.32 / *0.24$
Stainless steel (V2A)	$s_n \times 0.69$

Geometrical influence:

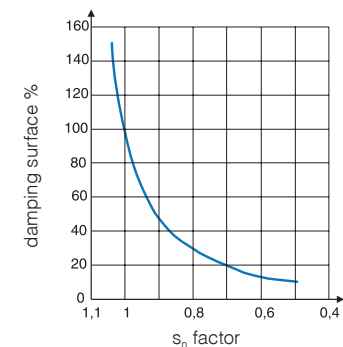

When using foils, an increase in the usable operating distance can be expected.

FULL INOX (SERIES 700)

Material influence (indicative values):

Target material	Operating distance
Steel type FE 360	$s_n \times 1.0$
Aluminum	$s_n \times 1.0$
Brass	$s_n \times 1.3$
Copper	$s_n \times 0.8$
Stainless steel (1 mm thick)	$s_n \times 0.5$
Stainless steel (2 mm thick)	$s_n \times 0.9$

Geometrical influence:

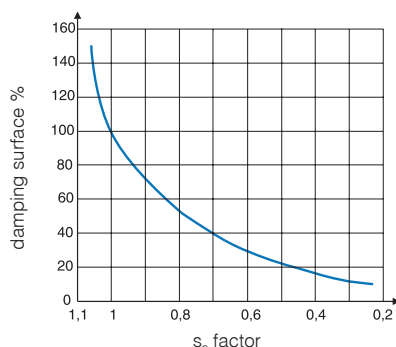

When using foils, a **decrease** in the usable operating distance can be expected.



Test card (Kodak paper, white)	100%
Paper, white	80%
PVC, gray	57%
Newspaper, printed	60%
Wood, lightly colored	73%
Cork	65%
Plastic, white	70%
Plastic, black	22%
Neoprene, black	20%
Automobile tires	15%
Aluminum sheet, untreated	200%
Aluminum sheet, black anodized	150%
Aluminum sheet, matt (brushed finish)	120%
Stainless steel, polished	230%

The specified sensing ranges of energetic diffuse sensors are achieved using standard matt white paper of the specified dimensions as the target surface. For other target surface materials, the correction factors listed here apply (these are guideline values only).

D

DARK-ON



The “dark-ON” function means that the relevant output is switched (carrying current) when **no** light is reaching the receiver.

DEGREES OF PROTECTION



The IP degrees of protection are defined in DIN 40050 / IEC 60529. The meaning of the **first numeral** is:

6 The housing provides complete protection against contact with electrically conducting or moving parts, and full protection against dust penetration.

and the **second numeral**:

4 Protection against water splashes: water splashed against the housing from any direction must have no harmful effect.

Test conditions: spraying with oscillating tube or spray nozzle; water pressure 1 bar; delivery rate 10 l/min \pm 5%; duration 5 minutes.

5 Protection against water jets: water projected by a nozzle from any direction under specified conditions must have no harmful effect.

Test conditions: nozzle with 6.3 mm diameter; delivery rate 12.5 l/min \pm 5%; distance 3 m; duration 3 minutes.

7 Protection against water when device is immersed in water under specified pressure and time conditions. Water must not penetrate in damaging quantities.

Test conditions: immersion depth in water 1 m; duration 30 minutes.

8 Protection against water when device is immersed in water indefinitely under specified pressure conditions. Water must not penetrate in damaging quantities.

Test conditions used by Contrinex: immersion depth in water 5 m; duration \geq 1 month.

9K Protection against water which, if directed against the housing from any direction and under considerably increased pressure, must have no harmful effect.

Test conditions: sensor mounted on table turning at 5 ± 1 rpm; spraying with flat nozzle; delivery rate 14 - 16 l/min; distance 100 - 150 mm; angles 0°, 30°, 60° and 90°; temperature $80 \pm 5^\circ\text{C}$ ($176 \pm 41^\circ\text{F}$); pressure 8,000 - 10,000 kPa (80 - 100 bar / 1160.8 - 1451 psi); duration 30 sec per position.

Devices with degree of protection **IP 67** are thus **not intended for prolonged operation in water**, or in prolonged humid conditions. Tolerance to liquids other than water must be examined from case to case.

E

EMBEDDABLE MOUNTING



See **MOUNTING**.

EMC



The EMC (**E**lectromagnetic **C**ompatibility) resistance of the devices satisfies the highest demands. For exact values, please refer to the data sheets.

All devices comply with the EU directive no. 2004/108/EC. In addition, they undergo severe field testing.

EXCESS-GAIN INDICATION (SYSTEM RESERVE INDICATION)



The excess-gain indication circuit detects the excess radiation power which falls on the light incidence surface and is processed by the light receiver. The excess gain can decrease in time due to dirt, a change in the target's reflection factor, and aging of the emitter diode, so that reliable operation can no longer be guaranteed. Some devices are therefore equipped

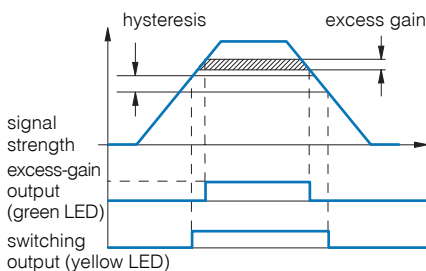

Fig. 19

with a second LED (green), which lights up when less than approximately 80% of the available operating distance is used. Models with an excess-gain output make the excess-gain signal available to the user for further processing. Thus, operating conditions which are no longer reliable can be recognized in time.

EXTRA DISTANCE FAMILY



The **Extra Distance** family (series 500/520) is one of three inductive sensing technologies offered by Contrinex. **Extra Distance** family sensors rely on conventional inductive oscillator and coil technology, but with a completely different signal evaluation circuit for better stability and therefore **long operating distances**. The most important contribution to this comes from the Contrinex Condist® oscillator (see pages 20-21).

Sensors are sized from Ø 4 to M30, with long operating distances up to 40 mm.

The Extra Distance technology family includes devices from the **Basic, Miniature, Extra pressure, High pressure** and **Analog output** ranges.

F

FULL INOX FAMILY



The **Full Inox** family (series 700) is one of three inductive sensing technologies offered by Contrinex. **Full Inox** family sensors rely on Contrinex's patented Condet® technology (see page 21).

Full Inox sensors have a one-piece, stainless steel housing and are exceptionally robust and chemically resistant. They are not only the most durable inductive sensors on the market, but also offer long operating distances on any conductive metal.

Sensors are sized from Ø 4 to M30 and cuboid variant of 20 x 32 x 8 mm, with long operating distances up to 40 mm and protection class IP 67 and IP 69K

The **Full Inox** technology family includes devices from the **Basic, Miniature, Extreme, High pressure, Washdown, Weld-immune, Chip-immune, Double-sheet** and **Maritime** ranges.

H

HYSTERESIS



Hysteresis (differential travel) causes a defined switching behavior of the device (Fig. 20). The sensing range always refers to the switch-on point.

Distance hysteresis is only useful for the diffuse sensor model and its related fiber version.

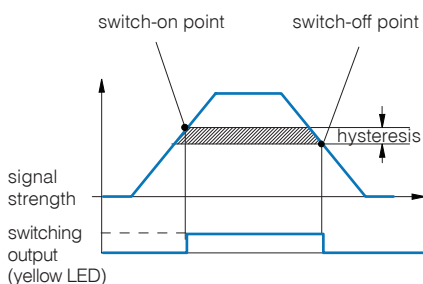

Fig. 20



Hysteresis (differential travel) causes a defined switching behavior of the device (Fig. 21). The operating distance always refers to the switch-on point. Namur devices and those with analog output have continuous transmission behavior, i.e. there is no hysteresis.

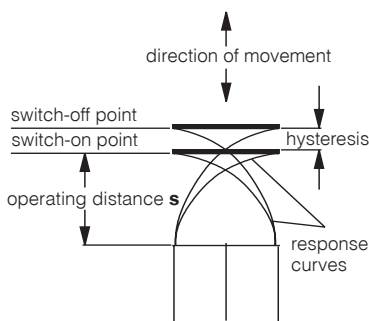

Fig. 21

I

INDUCTION PROTECTION



When inductive loads are switched off, the output voltage, without a protective circuit, would increase to a high value, which could destroy the output transistor. Contrinex sensors therefore contain a **Zener diode** at the output to limit the switch-off voltage to a safe value (3-wire types). When connecting an inductive load with a current >100 mA and simultaneously a switching frequency >10 Hz, the mounting of a **free-wheeling diode** directly to the load is recommended (due to the leakage power in the built-in Zener diode).

INSTALLATION



Photoelectric sensors can be easily and reliably installed in any position, using the mounting accessories supplied with most devices. The installation position should preferably protect the units against dirt and other contamination.



For inductive sensors, see **MOUNTING**.

INSULATION VOLTAGE



The devices in this catalog are designed for an insulation voltage (between connecting leads and housing) of 75 VDC / 50 VAC (for supply voltages up to 75 VDC / 50 VAC) or 300 VDC / 250 VAC (for supply voltages between 75 VDC / 50 VAC and 300 VDC / 250 VAC).

IP 64 / IP 65 / IP 67 / IP 68 / IP 69K



Refer to **DEGREES OF PROTECTION**.

IR LIGHT



IR is the abbreviation of “**Infra-Red**”. This refers to any electromagnetic radiation with a wavelength exceeding that of normal visible light, which is approx. 380 to 780 nm. Wavelengths of approx. 780 to 1500 nm are typically used. IR light cannot be used with synthetic fibers, due to high attenuation. Instead, visible red light is used. As the usual polarization filters cannot be used in the IR range, visible red light is also used for reflex sensors.



LEAD LENGTHS



For the sensor, long leads mean:

- a capacitive load at the output (see **CAPACITANCE**)
- increased influence of interference signals

Even under favorable conditions, lead lengths should not exceed **300 m**.

LEADS



The standard built-in leads are **not** suitable for **repeated bending stresses**. In such cases, high-flexibility PUR cables (special executions) or connectors with corresponding connecting cables (see pages 441-449) must be used.

LEAKAGE CURRENT



Leakage current is the current that flows through the output transistor and thereby through the load when the output is OFF (to be taken into account particularly where switches are connected in parallel).

LED



Most of the inductive devices in this catalog are equipped with a built-in yellow light-emitting diode (LED). It indicates the switching state: **output activated = yellow LED on**.



All photoelectric sensors have one or two **Light Emitting Diodes (LEDs)** built in. The yellow LED lights up when the output is switched (for switches with 2 outputs: the light-ON output). During a short-circuit or overload, the yellow LED does not operate. The green LED (if provided) lights up when enough system reserves (excess gain) for reliable operation are available, i.e. when an object is present in the reliable sensing area (diffuse sensors), or when enough light from the uninterrupted beam reaches the receiver (reflex and through-beam sensors).

LIGHT-ON



Light-ON means that the relevant output is switched (carrying current) when light is reaching the receiver.

LOAD RESISTANCE



From the selected supply voltage U_b and the specified maximum output current of the sensor, the lowest permissible load resistance for trouble-free operation can be calculated.

Example: With a voltage of 24 V and a specified maximum permissible output current of 200 mA, the minimum load resistance is 120 ohm; at 15 V, it is 75 ohm.

M

MAGNETIC FIELDS



Strong fields can saturate the ferrite core of inductive sensors, thereby increasing the operating distance, or even provoking false switching. However, no lasting damage is caused. **High-frequency fields** of several kHz (700 series), or several hundred kHz (other series), may seriously interfere with the switch functioning, since the oscillator frequency of the devices lies in this range. If difficulties with interfering magnetic fields are encountered, shielding is recommended.

MODULATED LIGHT



The photoelectric sensors listed in this catalog operate with modulated light, i.e. the light emitter is switched on only for a short period and remains switched off for much longer (ratio approx. 1:25). In diffuse and reflex sensors, the receiver is only active during the light pulse, and is disabled during the pulse gap. Operation with modulated light provides the following advantages:

- The devices are largely insensitive to ambient light
- Longer sensing ranges are possible
- Heat generation is reduced, which prolongs the operating life of the emitting diodes

MODULATION FREQUENCY



The photoelectric devices in this catalog are operated with modulated light, which makes them largely insensitive to ambient light. The modulation frequency f_{cy} is in the range of several kHz.

If a device is operated in the proximity of another device with the same modulation frequency, interference can occur.

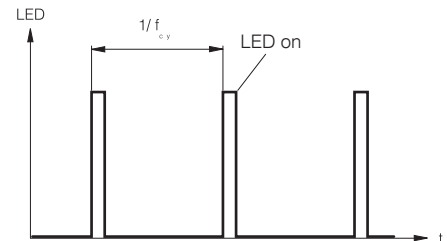

Fig. 22

MOUNTING



For photoelectric sensors, see [INSTALLATION](#).



EMBEDDABLE SENSORS

Embeddable sensors may be flush mounted in all metals. For trouble-free operation, a free zone according to Fig. 23 should be observed.

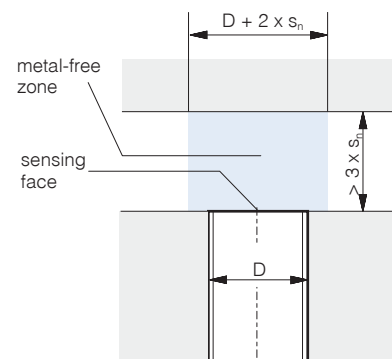

Fig. 23

QUASI-EMBEDDABLE SENSORS

When installing quasi-embeddable Extra Distance sensors (500 and 520 series) in conductive materials (metals), the devices must **protrude** by a distance **X**, according to Fig. 24. Further, a free zone of $3 \times s_n$ must be observed. Flush mounting in non-conducting materials is permitted.

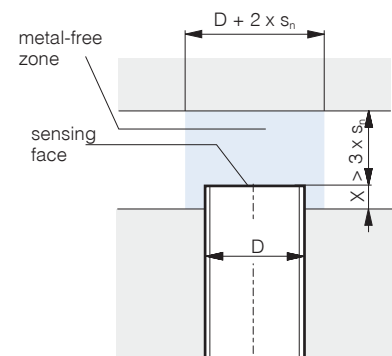

Fig. 24

Mounting in steel and in non-ferrous metals:

Housing size D	X (mm)
Ø 6.5	1
C8	1
M12	2
M18	4
M30	6

Mounting in stainless steel:

Housing size D	X (mm)
Ø 6.5	0.0
C8	0.0
M12	1.0
M18	1.5
M30	2.0

NON-EMBEDDABLE SENSORS

When mounting non-embeddable sensors in conducting materials (metals), minimum distances to the conducting material must be maintained according to Fig. 25. Flush mounting in non-conducting materials is permitted.

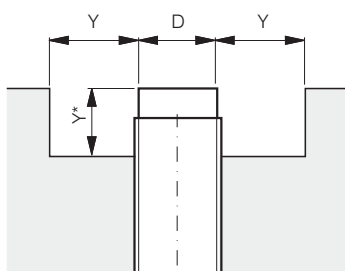

Fig. 25

Housing size D	Y (mm)
M8	8
M12	12
M18	22
M30	40
C44	60 / *40

N

NC



The output is closed when the switch is not activated. It is open when the switch is activated.

NO



The output is open when the switch is not activated. It is closed when the switch is activated.

NO-LOAD SUPPLY CURRENT



No-load supply current is understood as the inherent consumption of the sensor for operating the LED, amplifier, etc., in the non-activated state. It does not include the current flowing through the load.

NON-EMBEDDABLE MOUNTING



See **MOUNTING**.

NPN CONFIGURATION



The output device contains an NPN transistor, which switches the load towards zero voltage. The load is connected between the output terminal and the positive supply voltage $+U_B$ (Fig. 26).

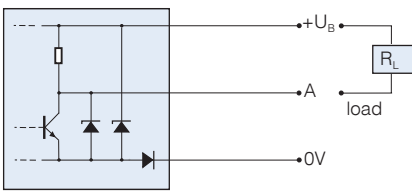

Fig. 26



OIL RESISTANCE



Long-term contact with any oils may affect plastics and weaken their resistance. However, inductive Full Inox sensors (series 700), as well as the sealed (series E) and high-pressure-resistant (series P) types can be used in **oily environments** without restriction. For all other types, this is not necessarily the case.

Thus, please observe the following:

Lubricating oils:

Generally cause no problems. Use versions with oil-resistant PUR cable (special executions).

Hydraulic oils, cutting oils:

These attack most plastics. In particular, PVC cables discolor and become brittle. Measures:

- Wherever possible, avoid contact with these liquids, particularly at the sensing face.
- Use versions with oil-resistant PUR cable.



For photoelectric sensors, housing, optical unit, and cable should be considered separately:

Housing

The PBTP / polybutyleneterephthalate (Crastin®) used for the housing is highly resistant to all conventional types of oil, in particular, to cutting and hydraulic oils, as well as drilling emulsions.

Optics

The windows are generally of glass (with the exception of series 4150 and 5050), and are therefore not affected. However, oil on the light in- and outputs changes their optical properties. The effects should be examined from case to case.

Cable

The PVC cable used as standard is not resistant to most types of oil, and becomes brittle in long-term use. The optional PUR cable should therefore be used in oily environments.

OPERATING DISTANCE



The operating distance of inductive sensors is the distance at which a target approaching the sensing face triggers a signal change. The operating distance is measured according to IEC 60947-5-2 / EN 60947-5-2, using a **standard square target** moving axially (Fig. 27). This target is made of steel, e.g. type FE 360 in accordance with ISO 630, with a smooth surface, square shape, and thickness of 1 mm (Fig. 28). The sides equal the **diameter** of the inscribed circle of the sensing face or **three times the rated operating distance s_n** of the sensor, whichever is the greater.

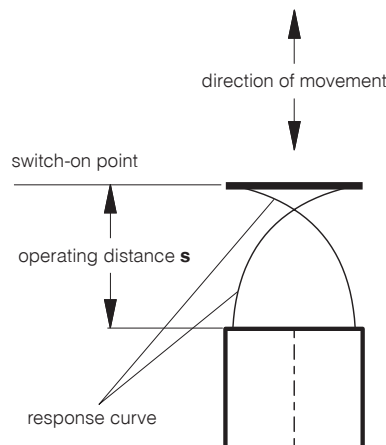

Fig. 27

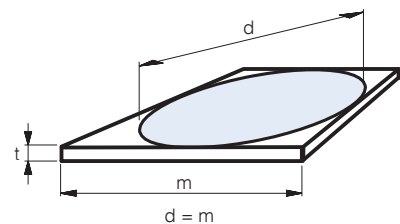

Fig. 28

Rated operating distance s_n

This is the operating distance for which the sensor is designed. It can be found under "technical data".

Effective operating distance s_r

The measured operating distance for a given switch according to IEC 60947-5-2 / EN 60947-5-2.

$$0.9 s_n \leq s_r \leq 1.1 s_n$$

This means that the manufacturing tolerance must not exceed $\pm 10\%$.

Usable operating distance s_u

This distance takes into account expected additional deviations caused by temperature and supply voltage fluctuations within the specified range.

$$0.9 s_r \leq s_u \leq 1.1 s_r$$

The temperature and supply voltage ranges can be found under "technical data".

Assured operating distance s_a

$$0 \leq s_a \leq 0.81 s_n$$

This operating distance is guaranteed by the manufacturer for all specified operating conditions. It is the **basis for a safe design**.



See **SENSING RANGE**.

OPTICAL FIBERS



An optical fiber can consist of a bundle of glass fibers, or one or more synthetic fibers. It is used to conduct light from one place to another, even around bends and curves. This is possible thanks to the phenomenon of total reflection. Total reflection always occurs when light coming from a material with a higher refractive index falls on an interface with a medium having a lower refractive index, in such a way that the critical angle required for total reflection is never reached.

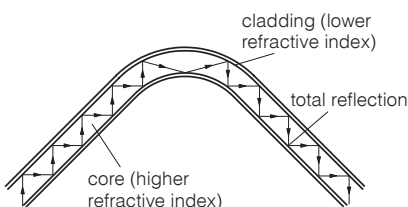

Fig. 29

The fibers consist of a core (with a higher refractive index) and a cladding (with a lower refractive index). Due to total reflection, the light is reflected backwards and forwards in the core, and can thus go round bends and curves.

OUTPUT CURRENT



The devices are designed for a given maximum output current. If this current is exceeded, even for only a short time, the **overload protection** trips. Incandescent lamps, capacitors, and other heavily capacitive loads (e.g. long leads) have a similar effect to overload (see also **CAPACITANCE**).

OUTPUT RESISTANCE



In order that the output voltage, even without external load, follows the switching state, Contrinex sensors contain a built-in output resistance (pull-up or pull-down resistor). For operation at high switching frequencies, an additional external load resistor must be added (to reduce the electrical time constant).

OVERVOLTAGE PROTECTION



For maximum operating reliability and ease of use, Contrinex sensors feature a built-in protection circuit against very short, non-periodic supply voltage peaks, which complies with the requirements of IEC 60947-5-2.

P

PARALLEL CONNECTION



Connecting sensors in parallel, in order to perform logic functions, is possible without any problem (Figs. 30 and 31).

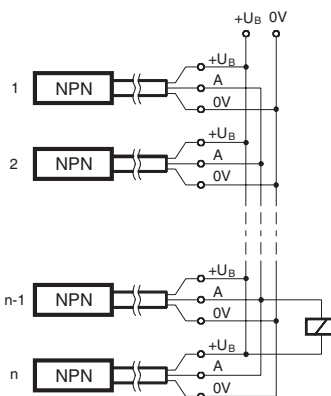

Fig. 30

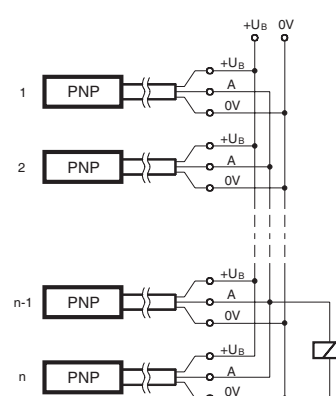

Fig. 31

Please note:

- The no-load supply current increases.
- Leakage currents add up, so that, even when closed, an inadmissible voltage drop can occur at the output.

PNP CONFIGURATION



The output device contains a PNP transistor, which switches the load towards the positive supply voltage $+U_B$. The load is connected between the output terminal and the negative supply voltage 0V (Fig. 32).

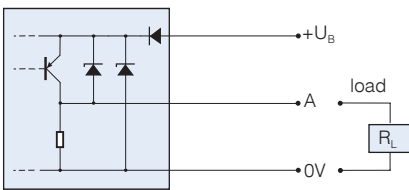

Fig. 32

POLARITY REVERSAL PROTECTION



Virtually all sensors in this catalog are protected against **any polarity reversal** at all terminals.

POLARIZATION FILTER

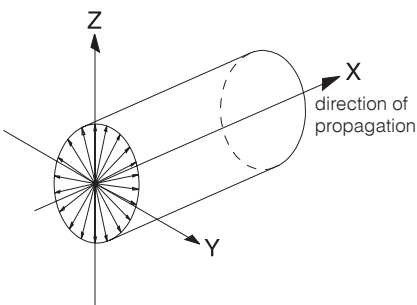

Fig. 33

Natural light (including the light from the emitter diodes) is not polarized (Fig. 33). When light has passed through a polarizing filter however, only that part of the original light which oscillates in the filter polarization direction is still present (Fig. 34). Polarization is retained after reflection by mirrored surfaces, only the direction of polarization may be altered. Diffuse reflection, on the other hand, destroys polarization. This difference can be used to suppress the disruptive effects caused by mirrored surfaces, by means of selection and configuration of suitable filters.

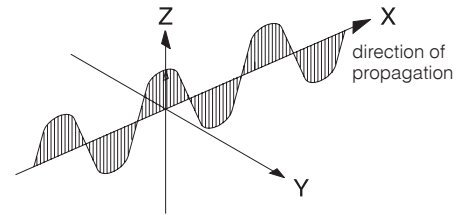

Fig. 34

POWER-ON RESET



When switched on, the sensor output is activated for a short time due to physical reasons, even without the presence of a target in front of the sensing face. Sensors with power-on reset therefore include an additional circuit that closes the output for a short time during the switching-on phase, so suppressing an error signal (this function is also known as "switch-on pulse suppression").

POWER SUPPLY UNITS



Circuit recommendations for suitable power supply units are shown in Figs. 35 and 36.

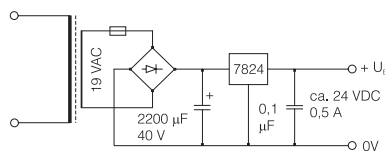

Fig. 35

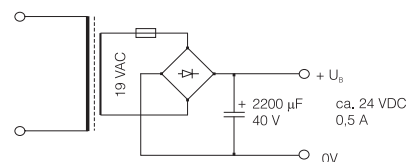

Fig. 36

The Contrinex accessory program also includes a suitable power supply unit (see page 455).

Please observe:

- Unsuitable power supply units are the most frequent reason for sensor problems!
- A transformer and rectifier are not sufficient; at least a smoothing capacitor is essential (due to the ripple content).
- Transformers with a 24 V output, rear-position rectifier and smoothing capacitor deliver a no-load voltage of well above 30 V. Consequently, devices with a maximum supply voltage of 30 V can be damaged.

R

REFLECTORS



By means of built-in polarization filters, polarized reflex sensors are designed so that they respond only to the light reflected from special reflectors. These operate according to the principle of the 3-way mirror (Fig. 37). The choice of the correct reflector for a specific application is determined by the required operating distance and installation possibilities. The reflector must be installed perpendicularly to the optical axis (tolerance $\pm 15^\circ$).

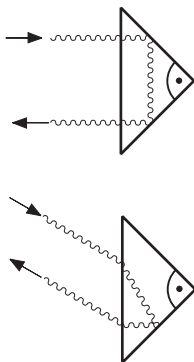

Fig. 37

REPEAT ACCURACY



Repeat accuracy (according to IEC 60947-5-2/EN 60947-5-2) is understood to be the repeat accuracy of the effective operating distance s_r , over an 8-hour period at an ambient temperature of $23 \pm 5^\circ\text{C}$ ($73.4 \pm 41^\circ\text{F}$) and with a specified supply voltage U_B . The specified repeat accuracy refers to this definition. Successive measurements made immediately one after the other generally lead to much better repeat accuracy.

RESPONSE DIAGRAM



The specified values for the operating distance refer to an **axial** approach of the target. For staggered or lateral movements, type-specific response curves are valid. Two typical examples are shown below (Fig. 38 and Fig. 39):

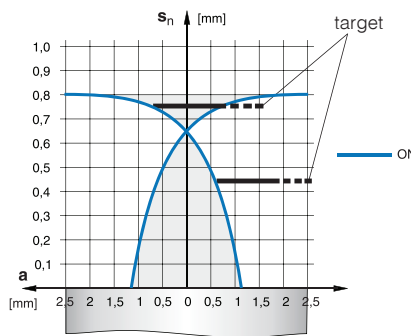

Fig. 38 DW-AD-603-M5

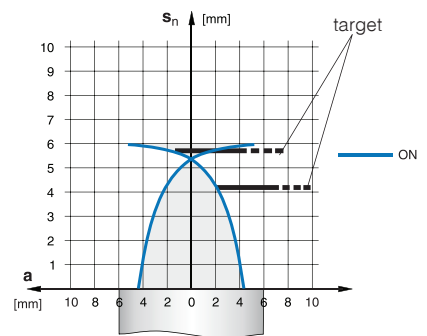

Fig. 39 DW-AD-503-M12

Depending on series, size, and mounting type (embeddable or non-embeddable), the response diagrams differ. Response diagrams for switch types not shown here are readily available from the corresponding individual data sheets. These can be found on the Contrinex website (www.contrinex.com), or ordered from our sales offices.

RIPPLE CONTENT



Too much ripple content causes undefined switching behavior. To remedy this, use a larger smoothing capacitor, or a stabilized power supply unit. The specified maximum supply voltage U_B must not be exceeded, not even during U_{SS} peaks.

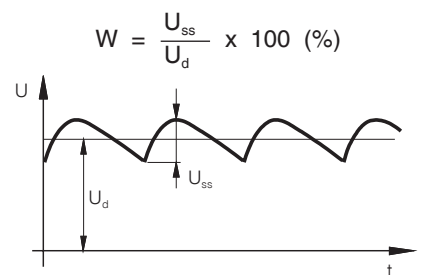

Fig. 40

S

SAFETY



The devices in this catalog have not been designed for safety-relevant use. In cases where the safety of people is dependent on their functioning, it is the user's responsibility to ensure that the relevant standards, in particular ISO 13849-1, and regulations are complied with. Contrinex assumes no liability for personal injury.

SENSING RANGE



The specified sensing range of photo-electric sensors is the maximum usable distance between the device and the standard target (diffuse sensors); between the device and the reference reflector (reflex sensors), and between the emitter and the receiver (through-beam sensors). The potentiometer must be set for maximum sensitivity, or for diffuse sensors with background suppression, for maximum sensing range. Moreover, the specified reflector (reflex sensors) or standard target (diffuse sensors) must be used.

SERIES CONNECTION



The connection of sensors in series in order to achieve logic functions is possible, but not recommended. The same effect can be achieved by the **parallel connection** of sensors with **NC function** (instead of the series connection of models with NO function), or vice versa. However, please note that, as a result, the output signal is inverted.

SHOCK RESISTANCE



The sensors in this catalog are tested for resistance to a shock of 30 g (30 times gravitational acceleration) for a period of 11 ms, according to IEC 60068-2-27.

SHORT-CIRCUIT PROTECTION



The devices in this catalog feature built-in pulse protection against short-circuits and overloads, which alternately closes and opens the output when the maximum output current is exceeded, until the short-

circuit is eliminated. Short-circuits between the output and the supply voltage terminals do not damage the sensor, and are allowed in permanence. The same applies to overloads. During short-circuits, the LEDs do not function.

SPHERICAL OPTICS



Spherical lenses are special versions of double convex lenses. They feature a short focal length and a good light incidence area. Fig. 41 shows such a design in sensor type LT#-1040/1050-30#-50# (see pages 229-235).

For diffuse sensors, the sphere is cut in two to separate the reception from the emission channel.

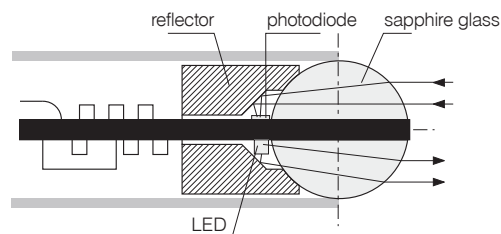

Fig. 41

The emitter and receiver chips are mounted as closely as possible to the surface of the sphere and slightly off the optical axis (see Fig. 41). This causes the emitted beam to intersect the receiver's sensing range at a specific distance from the device, resulting in a relatively short sensing range, but a virtually cylindrical detection zone. A cylindrical detection zone is particularly useful in some applications, such as the detection of targets through narrow holes or gaps.

STANDARDS



The sensors in this catalog comply, either completely or to a great extent, with the following standards:

- IEC 60947-5-1, **IEC 60947-5-2**, EN 60947-5-1, **EN 60947-5-2**
- IEC 61000-4-1, 61000-4-2, 61000-4-3, 61000-4-4, DIN EN 55011, DIN EN 55081-2, DIN EN 50140
- IEC 60529 / DIN 40050
- IEC 60947-1 / EN 60947-1 / DIN VDE 0660, part 100, part 100 A3, part 200, part 208
- DIN EN 50008, 50010, 50025, 50026, 50032, 50036, 50037, 50038, 50040, 50044

SUPPLY VOLTAGE U_B



The specified maximum supply voltages must **not be exceeded**. For maximum operating reliability and ease of use, Contrinex sensors contain a built-in protection circuit against very short, non-periodic, supply voltage peaks, which complies with the requirements of IEC 60947-5-2. Operating voltages below the lower specified limit, even for short periods, do not damage the switches, but impede their operation.

SWITCHING FREQUENCY



The maximum switching frequency of inductive sensors indicates the highest permissible number of pulses per second for a constant pulse/pause ratio of 1 : 2 at **half the rated operating distance s_n** . Measurement is according to IEC 60947-5-2 / EN 60947-5-2 (Fig. 42).

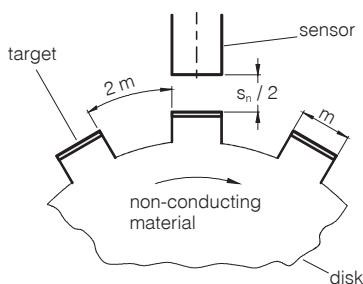

Fig. 42



In the case of photoelectric sensors, the frequency of operating cycles (f) is determined from the formula:

$$f = \frac{1}{t_{on} + t_{off}}$$

where:

t_{on} is the turn on time

t_{off} is the turn off time

t_{on} and t_{off} are measured in accordance with IEC60947-5-2 2007 paragraph 8.5.3. (see also **Turn-on/turn-off time**, in this glossary).

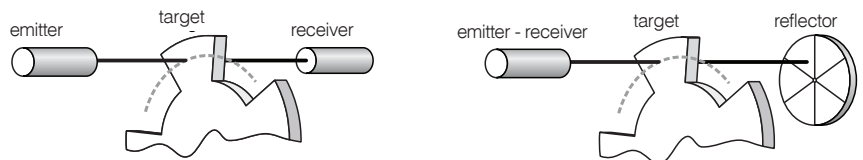

Fig. 43: Through-beam and reflex modes: the light beam must be fully broken by the target.

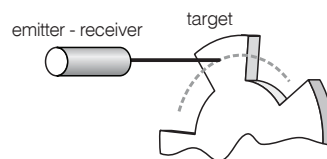

Fig. 44: Diffuse mode: the target must be of the same material as the standard target.

T

TEACH-IN



Some devices have a teach-in capability instead of a potentiometer to adjust their sensing range, etc. Teach-in is achieved either directly by pressing a button or remotely via IO-Link.

TEMPERATURE DRIFT



The set sensing ranges are subject to slight temperature influences. Due to built-in temperature compensation, this effect is much less important for devices of the 4040 series (approx. 0.1 % / °C) than for the other switches (approx. 0.3 % / °C). The sensing range, as a function of ambient temperature, follows approximately the curves shown in Fig. 45.

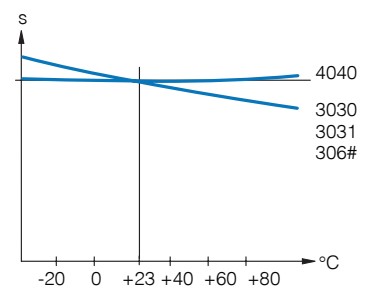

Fig. 45



The specified operating distances refer to a nominal ambient temperature of 23°C (73.4°F). The operating distance, as a function of ambient temperature, follows approximately the curve shown in Fig. 46.

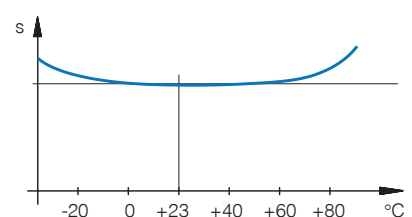

Fig. 46

The temperature of the target itself has practically no influence on the operating distance. Within the permitted temperature range of, as a rule, -25°C to + 70°C (-13°F to + 158°F), the operating distance varies by a maximum of ± 10% compared to its value at 23°C (73.4°F).

TURN-ON / TURN-OFF TIME



The output **turn-on** time t_{on} is the minimum period of time required for a sensor to detect the **presence** of a light beam and output an ON signal.

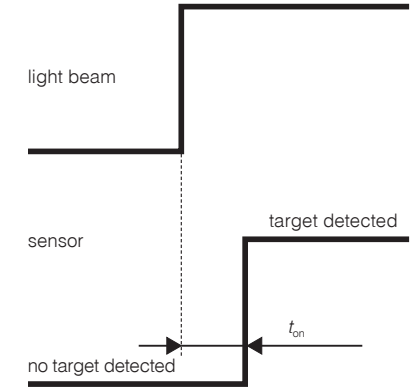

Fig. 47: Output turn-on time

The output **turn-off** time t_{off} is the minimum period of time required for a sensor to detect the **absence** of a light beam and output an OFF signal.

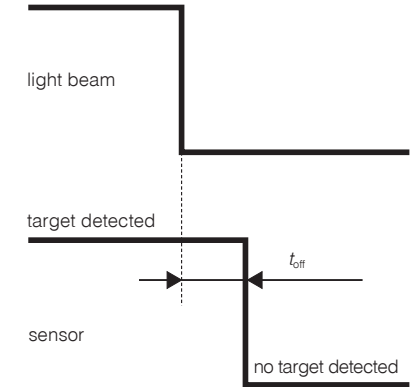

Fig. 48: Output turn-off time

t_{on} and t_{off} are measured in accordance with IEC60947-5-2 2007 paragraph 8.5.3.

TEST INPUT



The emitters of through-beam sensors are provided with a test input. Light emission can be switched on and off by means of this input, which, together with the corresponding evaluation of the receiver reaction, permits very efficient sensor monitoring.

TIGHTENING TORQUE



Over-tightening of the nuts can mechanically damage cylindrical sensors. The specified maximum permissible tightening torques must therefore not be exceeded.



CLASSICS / EXTRA DISTANCE (SERIES 500*, 520*, 600, 620)

Housing size D	M (Nm)
M4	0.8
M5	1.5
C5	0.2
M8	8 / *4
C8	1
M12	10**
M18	25
M30	70
C44	2.5

** 6 Nm for the first 10 mm

FULL INOX (SERIES 700)

Housing size D	M (Nm)
M8	8
M12	20
M18	50
M30	150

SERIES 1040 / 50, 1120, 1180, 1180W

Housing size D	M (Nm)
M5	1.5
M12	10
M18 / M18W	20

TIME DELAY BEFORE AVAILABILITY



The time delay before availability is the maximum time the sensor requires for **operating readiness** after the supply voltage has been switched on.

V

VIBRATION RESISTANCE



The sensors in this catalog are tested for resistance to vibrations of 1 mm amplitude at 55 Hz, according to IEC 60068-2-6.

VOLTAGE DROP



In the switched-through condition, a (current dependent) voltage drop develops across the output transistor; the output voltage, therefore, does not entirely reach the corresponding supply voltage (to be particularly taken into account with series connection and electronic inputs).

W

WIRE-BREAK PROTECTION



All sensors in this catalog are equipped with wire-break protection. If a voltage supply lead breaks, the output is disabled, thus avoiding an error signal.

WIRING



Sensor cables must not be laid in parallel in the same cable runs as cables connected to **inductive loads** (i.e. protection solenoids, magnetic rectifiers, motors, etc.), or which conduct currents from **electronic motor drives**. Leads should be kept as short as possible; however, with suitable wiring (low coupling capacitance, small interference voltages), they can be up to 300 m long.

To reduce electromagnetic interference, apply the following measures:

- Maintain the distance to interfering cables > 100 mm
- Use shields
- Install inductances (contactors, magnetic rectifiers, relays) with RC networks or varistors

INDUCTIVE SENSORS

DW-AD-503-M8E (-12X/-XXX)

INDUCTIVE SENSOR DW

SENSOR TYPE

Conventional	A
2-wire DC (NAMUR excepted)	D
High-temperature	H
Food and sea-water	L
Maritime	M

CONNECTION

Cable	D
Connector	S
Cable + connector	V

SERIES

500 / 520 (Extra Distance)	5
600 / 620 (Classics)	6
700 (Full Inox)	7

Embeddable / quasi-embeddable	0
Non-embeddable	1
Increased operating distance, (quasi-)embeddable	2
Increased operating distance, non-embeddable	3

OUTPUT

NPN NO	1
NPN NC	2
PNP NO	3
PNP NC	4
PNP changeover	A
NPN changeover	B

SHORT / SPECIAL EXECUTIONS

Series E (impervious)	E
Series 700P (all-metal & high-pressure resistant)	G

HOUSING SIZE

Threaded	
M4	4
M5	5
M8	8
M12	12
M18	18
M30	30
M50	50
Smooth	
Ø 3 mm	3
Ø 4 mm	4
Ø 6.5 mm	65
Ø 8 mm	80
5 x 5 mm	5
8 x 8 mm	8
20 x 32 mm	23
40 x 40 mm	44

HOUSING

Threaded cylindrical housing	M
Rectangular housing	C
Smooth cylindrical housing	0
High-pressure resistant	P

OUTPUT

2-wire DC	
NO / NAMUR	5
NC	6

2-wire AC/DC	
NO	7
NC	8
Analog	9



ALL OVER THE WORLD

EUROPE

Austria
Belgium**
Croatia
Czech Republic
Denmark
Estonia
Finland
France**
Germany**
Great Britain**
Greece
Hungary
Ireland
Italy**
Luxembourg
Netherlands
Norway
Poland
Portugal**
Romania
Russian Federation
Slovakia
Slovenia

Spain
Sweden
Switzerland**
Turkey
Ukraine

AFRICA

Morocco
South Africa

THE AMERICAS

Argentina
Brazil**
Canada
Chile
Mexico**
Peru
United States**

ASIA

China**
India**
Indonesia

Japan**

Korea
Malaysia
Pakistan
Philippines
Singapore**
Taiwan
Thailand
Vietnam

AUSTRALASIA

Australia
New Zealand

MIDDLE EAST

Israel
United Arab Emirates

Terms of delivery and right to change design reserved.

* Status April 2018, own assessment

** Contrinex subsidiary

HEADQUARTERS

CONTRINEX AG Industrial Electronics
Route du Pâqui 5 - PO Box - CH 1720 Corminboeuf - Switzerland
Tel: +41 26 460 46 46 - Fax: +41 26 460 46 40
Internet: www.contrinex.com - E-mail: info@contrinex.com



www.contrinex.com

