



# EXCELLENT RESOLUTION FOR SMALLEST VARIATIONS



## COLOR AND CONTRAST PHOTOELECTRIC SENSORS

### KEY ADVANTAGES

- ✓ Rugged housing, 40 mm x 50 mm x 15 mm
- ✓ Connector adjustable at 0°, 45° and 90°
- ✓ 5 switching tolerance levels

### Color sensors

- ✓ 3 color teach channels with independent outputs
- ✓ High positioning tolerance
- ✓ High switching frequency: up to 4 kHz

### Contrast sensors

- ✓ Detection of very small print marks thanks to a narrow, collimated light spot
- ✓ RGB emission technology with best emission color automatically selected
- ✓  **IO-Link**

#### RANGE OVERVIEW

### COLOR AND CONTRAST

#### Series

4050 (40x50x15)

#### Color

p. 289

#### Contrast

p. 289



# COLOR AND CONTRAST

# 4050

# PHOTOELECTRIC SENSORS

## ADVANTAGES

- ✓ Rugged housing, 40 mm x 50 mm x 15 mm
- ✓ Connector adjustable at 0°, 45° and 90°
- ✓ 5 switching tolerance levels

### Color sensors

- ✓ 3 color teach channels with independent outputs
- ✓ High positioning tolerance
- ✓ High switching frequency: up to 4 kHz

### Contrast sensors

- ✓ Detection of very small print marks thanks to a narrow, collimated light spot
- ✓ RGB emission technology with best emission color automatically selected
- ✓ Excellent tolerance to target distance variations
- ✓ High switching frequency: up to 10 kHz
- ✓  **IO-Link**

## WIRING DIAGRAMS

PNP or NPN, 3 outputs



PUSH-PULL, 1 output + teach or switching mode selector

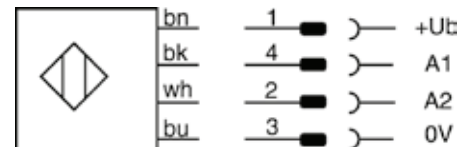

OVERVIEW	4050 COLOR	4050 CONTRAST
Housing material	PBTP	PBTP
Degree of protection	IP 67	IP 67
Supply voltage range	10 ... 30 VDC	10 ... 30 VDC
Ambient temperature range	-5 ... +55°C / 23 ... +131°F	-5 ... +55°C / 23 ... +131°F
Output current	≤ 200 mA	≤ 100 mA
Switching frequency	4000 Hz	10,000 Hz
Compatible mounting bracket	See page 302	See page 302

# 4050 SERIES



4050

HOUSING SIZE MM	40 X 50 X 15	40 X 50 X 15
OPERATING PRINCIPLE	COLOR SENSOR (DIFFUSE)	CONTRAST SENSOR (DIFFUSE)
SENSING RANGE MM	40	12

Inductive

Photoelectric

Safety

RFID

Connectivity

Accessories

Glossary

Index

## PHOTOELECTRIC

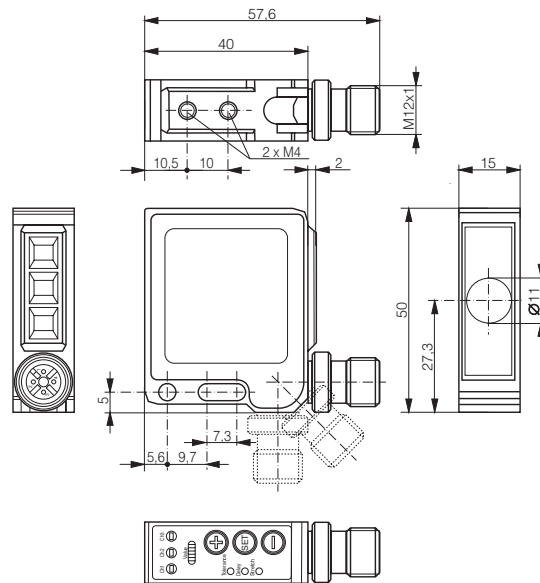

DATA		IO-Link
Light source	LED white	LED red, green, blue (autoselect)
Light spot size (distance)	Ø 4 mm (35 mm)	1.5 x 3.5 mm (12 mm)
No-load supply current	≤ 35 mA	≤ 35 mA
Setup	Teach button	Teach button or Teach input or IO-Link
3 x PNP Light-ON	<b>FTS-4155-303</b>	
3 x NPN Light-ON	<b>FTS-4155-301</b>	
PUSH-PULL		<b>KTS-4155-407</b>
Other types available	Cable version	Cable version



# PHOTOELECTRIC SENSORS

## HIGHLIGHTS:



- ✓ Complete C23 series with first-class sensing ranges
- ✓ Excellent background suppression sensors
- ✓ Smallest self-contained miniature sensors on the market
- ✓ Wide range of fiber-optic amplifiers, including  IO-Link
- ✓ Excellent color and contrast recognition sensors

















## NEW:

- ✓ C23 sensors with patented UV technology for transparent object detection, including  IO-Link
- ✓ M18 series with short plastic housing and  IO-Link
- ✓ Distance measurement sensors in C23 and C55 size with  IO-Link
- ✓ Detection and measurement light grids



# PROGRAM OVERVIEW

	SERIES		1040	1050	1120	M18P	1180
	HOUSING SIZE IN MM		∅ 4 IO-Link 2019	M5 IO-Link 2019	M12 IO-Link 2019	M18 IO-Link	M18 IO-Link 2019
	OPERATING PRINCIPLE	SENSING RANGE	CYLINDRICAL				
STANDARD	Diffuse				☑ p.191	☑ p.196	☑ p.200-201, 205 
	Background suppression					☑ p.195	☑ p.199-200
	Reflex				☑ p.192	☑ p.197	☑ p.202-203
	Through-beam				☑ p.192-193 	☑ p.197	☑ p.203-204, 206 
MINIATURE	Diffuse		☑ p.229-231	☑ p.232-234			
	Background suppression						
	Reflex						
	Through-beam		☑ p.231	☑ p.235			
TRANSPARENT OBJECT	Reflex, UV light						
	Reflex, red light						
FIBER OPTIC SENSORS AND FIBERS	Amplifier						
	Plastic fiber						
	Glass fiber						
DISTANCE	Short range						
	Medium range						
COLOR AND CONTRAST	Color						
	Contrast						
LIGHT GRIDS	Detection						
	Measurement						

											Inductive
0507	C12	C23	3030	3060	4040	4050	C55	DGI	MGI		
5x7x40	13x21x7 13x27x7	20x30x10 20x34x12  IO-Link	30x30x15	31x60x10  IO-Link	40x40x19	40x50x15  IO-Link	50x50x23  IO-Link	40x20xH	40x20xH		Photoelectric
CUBIC											Safety
		 p.210	p.215-216			p.221					
		 p.209	p.213-214			p.221	p.225 				
		 p.211	p.217-218			p.222					
		 p.211	p.219			p.222					
p.237											RFID
	p.239-240										
	p.240										
	p.241										
		 p.245									Connectivity
		 p.246-247									
			p.253-254	 p.257-259	p.261						Accessories
			p.262-271	p.262-271							
			p.277		p.272-276						
		p.283 									Glossary
							 p.285 				
						p.289					
						 p.289					
								p.293			Index
									p.295		

# PROGRAM OVERVIEW

HOUSING SIZE	SENSING RANGE						PAGE
	1 mm	10 mm	100 mm	1000 mm	10,000 mm	100,000 mm	
<b>DIFFUSE</b>							
∅ 4 mm / M5	10 mm						229, 232
∅ 4 mm / M5	20 mm						230, 233
∅ 4 mm / M5	50 mm						231, 234
5 x 7 mm	20 mm						237
5 x 7 mm	50 mm						237
5 x 7 mm	90 mm						237
M12	300 mm						191
M18P	1200 mm						196
M18 (M18W)	600 mm						200-201
M18 ⚠	250 mm						205
M18 ⚠	600 mm						205
C23	1500 mm						210
30 x 30 mm	600 mm						215
30 x 30 mm	1200 mm						216
40 x 50 mm	1200 mm						221
<b>BACKGROUND SUPPRESSION</b>							
M18P	250 mm						195
M18 (M18W)	120 mm						199-200
C12	15 mm						239
C12	30 mm						240
C12	120 mm						239
C23	300 mm						209
30 X 30 mm	200 mm						213-214
40 X 50 mm	500 mm						221
C55 ⚠	5000 mm						225
<b>REFLEX</b>							
M12	1500 mm						192
M18P	7000 mm						197
M18 (M18W)	2000 mm						202-203
C12	3000 mm						240
C23	8000 mm						211
C23 (TRU)	1200 mm						245
C23 (TRR)	5000 mm						246-247
30 X 30 mm	2000 mm						217
30 X 30 mm	4000 mm						218
40 X 50 mm	4000 mm						222
<b>ANALOG OUTPUT</b>							
30 x 30 mm	100 mm						213



HOUSING SIZE	SENSING RANGE						PAGE
	1 mm	10 mm	100 mm	1000 mm	10,000 mm	100,000 mm	
<b>THROUGH-BEAM</b>							
Ø 4 mm						250 mm	231
M5						250 mm	235
M12					10,000 mm	192	
M12 ⚠					50,000 mm	193	
M18P					30,000 mm	197	
M18 (M18W)					20,000 mm	203-204	
M18 ⚠					50,000 mm	206	
C12					2000 mm	241	
C23					30,000 mm	211	
30 x 30 mm					6000 mm	219	
30 x 30 mm					12,000 mm	219	
40 x 50 mm					50,000 mm	222	
<b>FIBER-OPTIC AMPLIFIER</b>							
30 x 30 mm						60 mm	253
30 x 30 mm						120 mm	254
31 x 60 mm						100 mm	259
31 x 60 mm						200 mm	257-258
40 x 40 mm						150 mm	261
<b>CONTRAST</b>							
40 x 50 mm						12 mm	289
<b>COLOR</b>							
40 x 50 mm						40 mm	289
<b>DISTANCE MEASURING</b>							
C23						80 mm	283
C23 ⚠						100 mm	283
C23					200 mm	283	
C55 ⚠					5000 mm	285	
<b>LIGHT GRIDS</b>							
40 x 20.5 mm (Detection grid)					8000 mm	293	
40 x 20.5 mm (Measurement grid)					4000 mm	295	

Inductive

Photoelectric

Safety

RFID

Connectivity

Accessories

Glossary

Index

# INTRODUCTION

## OPERATING PRINCIPLE

The light-emitting diode (LED) emits a beam of modulated light towards the target. This beam is interrupted by the target, causing partial reflection. A part of the reflected light reaches the sensing face of the receiver. Depending on the operating principle, either the interrupted beam or the reflected light is used for further processing.

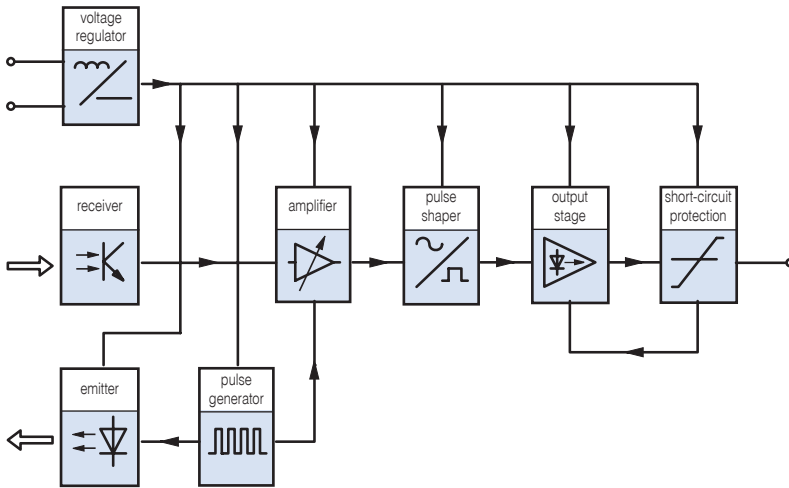

Fig. 9: Functional blocks of a photoelectric sensor

## TECHNOLOGY FAMILIES

Contrinex photoelectric devices are divided into five **technology families**, depending on their operating principle. The program includes energetic **diffuse** sensors, diffuse sensors with **background suppression**, **reflex** sensors, **through-beam** sensors and sensors with **analog** output.

### DIFFUSE

#### Versatile and cost-effective

A diffuse-mode, or energetic-diffuse, photoelectric sensor is a reflective sensor, containing a transmitter and a receiver in a single housing. The sensor emits a light beam toward a distant target that acts as a reflector, returning part of the transmitted light to the sensor. The receiver detects the amount of light reflected by the target, triggering the sensor when the light intensity reaches a threshold value.

Diffuse-mode sensors are cost-effective as they do not require separate reflectors or receivers, and detect reflective targets with ease. Sensing range depends on the target's size, shape, color and surface finish, although sensor sensitivity is adjustable during installation to compensate for targets with poor reflective qualities.

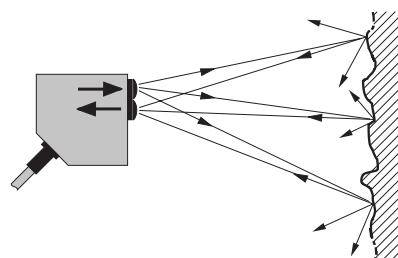

Fig. 10: Diffuse sensing

### BACKGROUND SUPPRESSION

#### Excellent suppression of light-colored backgrounds

Diffuse-mode photoelectric sensors with background suppression emit a focused light beam toward a distant target. Part of the beam is reflected from the target and returns to the sensor, striking a position-sensitive receiver. The receiver distinguishes

between reflections from the target and reflections from background objects, only triggering the sensor when the signal reaches a value that relates to the preset target distance.

The sensing range is practically insensitive to the target's size, color, shape and surface finish, and background-suppression sensors provide highly reliable detection of "difficult" targets, even against a light background. Stable, accurate detection of small, fast-moving parts on conveyors or automated machinery is possible over the entire sensing range, eliminating false triggering by objects in the background.

### REFLEX

#### Long sensing range in a single-housing device

A reflex, or reflective, photoelectric sensor contains a transmitter and a receiver in a single housing, and emits a pulsed, focused light beam toward a distant reflector. Reflected light returns to the sensor, arriving at the receiver. When a target object interrupts the light beam, the receiver detects the reduced light intensity and triggers the sensor.

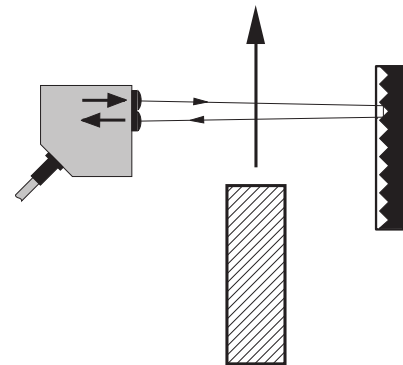

Fig. 11: Reflex sensing

The relatively high level of reflected light allows reflex sensors to achieve sensing distances up to eight meters. For applications where the target object itself reflects light back toward the sensor, models with polarization filters are available. The filters ensure that only light returned from the reflector reaches the receiver, ensuring reliable detection, even with reflective targets.

## THROUGH-BEAM

### Emitter and receiver in separate housings for sensing ranges from 0 to 50 m

A through-beam photoelectric sensor comprises an emitter and receiver, each mounted in a separate housing. The emitter is aligned so that the greatest possible amount of pulsed light from its emitting diode reaches the receiver (Fig. 12). The receiver, which is mounted beyond the target area, processes incoming light in such a way that it is clearly separated from ambient and other light sources. Any interruption of the light beam by a target triggers the sensor, causing its output signal to switch. For reliable operation, the target must be completely opaque, and its size should be at least equal to the diameter of the receiver's aperture.

Contrinex through-beam photoelectric sensors are ideal for industrial applications where sensing components must be mounted some distance from the target area. Through-beam sensors utilize infrared, visible and laser light sources to detect opaque and semi-transparent targets, reliably and repeatably, at extended distances. They are available in cylindrical versions from subminiature ( $\varnothing 4$ ) to small (M18) and cubic versions from miniature (20 mm x 30 mm x 10 mm) to small (40 mm x 50 mm x 15 mm).

## ANALOG OUTPUT

### Precise distance control

Photoelectric sensors with analog outputs are ideal for measuring absolute values of distance. Using background suppression-mode technology, analog photoelectric sensors produce an output signal that is accurately calibrated and approximately proportional to the distance of the target from the sensor. Users have a choice of current or voltage outputs that are compatible with all modern control systems.

Contrinex analog photoelectric sensors provide all the advantages of standard diffuse-mode sensors, and measure target distances up to 100 mm.

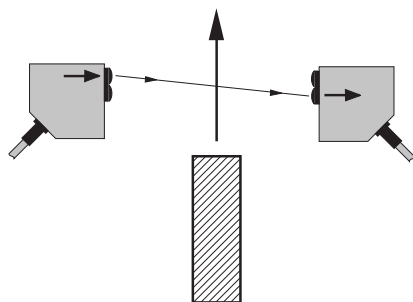

Fig. 12: Through-beam sensing

of process data, continuous diagnosis of sensor status, advanced parameter settings, sensitivity adjustment, a remote teach function and easy checking of sensor ID, to ensure the right sensor is at the right place. See page 186.

## MINIATURE

### Smallest on the market

The Contrinex **Miniature** range packs exceptional position- and presence-sensing performance into the smallest self-contained photoelectric sensors on the market. Designers have the choice of through-beam or diffuse sensors in  $\varnothing 4$  and M5 cylindrical metal housings that offer multiple mounting methods and beam orientation. For fully embedded applications, sensors with spherical sapphire-glass lenses produce focused, cylindrical light beams.

Types with a 5 mm x 7 mm stainless-steel housing and a narrowly focused, cylindrical light beam are suitable for vertical or horizontal mounting directly on the supporting surface. Best-in-class sensing distances of up to 90 mm allow them to be positioned at a safe distance from the target.

The **C12** Series (13.5 mm x 21.8 mm x 7.7 mm) with small visible light spot thanks to red pinpoint LED offers long sensing ranges up to 2000 mm in a through-beam type and 3000 mm in a polarized reflex type. Two background suppression types are available with fixed sensing ranges up to 15 mm or 30 mm. A third type with 3-turn potentiometer (13.5 mm x 27.5 mm x 7.7 mm) reliably detects objects up to 120 mm.

## PRODUCT RANGES

### STANDARD

#### First-class performance for general use

Contrinex **Standard** photoelectric sensors are ideal for general position- and presence-detection in almost any industry. With first-class sensing ranges and outstanding background suppression characteristics, the Standard range of sensors delivers very high accuracy and reliability. Light sources include infrared, laser and pinpoint LED.

The **Standard** range offers a wide choice of cubic sizes: **C23** (20 x 30 x 10 mm), **3030** (30 x 30 x 15 mm), **4050** (40 x 50 x 15 mm) and **C55** (50 x 50 x 23 mm). Cylindrical types are available in sizes **M12** and **M18**, including some M18 types with housings adapted for right-angle detection.

**Standard C23** and **M18P** series are high quality ASIC sensors with an integral **IO-Link** interface in PNP types. This makes them particularly suitable for smart factory applications. IO-Link extends sensor functionality to include continuous monitoring



# INTRODUCTION

## TRANSPARENT OBJECT

### Outstanding reliability and ease of adjustment

The Contrinex **TRU-C23** photoelectric sensor is ideally suited for the presence control of transparent objects. Its patented technology uses **UV light**. Since transparent materials like plastic or glass absorb large amounts of polarized UV light, it is very easy to set the threshold at which the sensor switches. The shape or thickness of the target has no influence on detection. In addition, sensor performance is unaffected by dirt, water drops or aging.



The sensor system comprises an LED that emits polarized UV light and a UV reflector. Overall, the sensor's operating range is around **1200 mm**. Special optics with autocollimation ensure reliable detection and no blind zone, even close to the sensor or through a small notch. For applications requiring the detection of thicker or larger transparent objects, the **C23 Transparent Standard** can be the ideal solution. It operates with polarized, red light and has a maximum operating range up to **5000 mm**. Typical fields of application can be found in the food, pharmaceutical and packaging industries. Both sensor types include an IO-Link interface (see page 186).

## FIBER-OPTIC SENSORS AND FIBERS

### Reliable short and long-range sensing

The highly versatile **Fiber-Optic** range includes the self-contained **3030** and **4040** series (30 mm x 30 mm x 15 mm and 40 mm x 40 mm x 19 mm) and the DIN-rail mounted **3060** series (31 mm x 60 mm x 10 mm), suitable for multiple-sensor applications. **Synthetic fibers** are available for general use and **glass fibers** for high temperatures and aggressive environments.

Customers requiring intrinsically safe photoelectric sensors with DIN-rail-mounted electronics need not look beyond the Contrinex **3060** series of fiber-optic amplifiers. In a Crastin® housing, every model combines ease of set-up with market-leading features, including **IO-Link** (see page 186). With switching times as low as 0.1 millisecond, 3060 fiber-optic amplifiers are ideal for sensing fast-moving targets in demanding environments, including robotics, precision handling systems and printed circuit board production.

Distance setting is accomplished either by adjustment of a multi-turn potentiometer or by use of a teach-in function with manual fine adjustment. An optional digital display (model 3066) is also available. Using blue-light sources (model 3360), detecting glass is possible at distances up to 100 mm.

Fiber-optic sensors are common in explosive environments or in the presence of strong electromagnetic fields, but also in confined spaces. With bend-radii as small as 2 mm, reliable, accurate sensing is possible even in the most inaccessible areas.



## DISTANCE

### High precision and direct digital transmission

**DTR-C23** and **DTL-C23** sensors use a triangulation method for highly accurate distance measurement at short range. Types with red light (DTR-C23) measure distances of **20 to 80 mm** or **30 to 200 mm**, while the measurement range for laser types (DTL-C23) is **20 to 100 mm**. Applications include small-part detection, position or height checking and monitoring material thickness on winding rolls.

For ranges up to **5000 mm**, **DTL-C55** sensors use the optical time-of-flight (TOF) method. In the **IO-Link** version, measurements are passed directly to the control system as millimeter values in digital form, with no need for an analog-to-digital converter and no signal drop for long lines. In addition, IO-Link provides diagnostic and other functions (see page 186). With two virtual switching points settable either via teach-in or direct parameter write-in, this sensor is ideal for use in mobile logistics, such as forklift trucks.

With both methods, distance measurement is largely independent of target color or surface characteristics. Detected distances can be output via an adjustable analog output and, for a digital output, a switching window of acceptance may be configured by teach-in.

The housings of **DTR-C23** and **DTL-C23** sensors (20 mm x 34 mm x 12 mm) and **DTL-C55** sensors (50 mm x 50 mm x 23 mm) have an **IP67/IP69K** enclosure rating. DTL-C55 sensors have **Ecolab** certification.



## COLOR AND CONTRAST

### Excellent resolution for smallest variations

**Color** photoelectric sensors utilize energetic-diffuse sensing technology to detect variations in target color, allowing color sorting or color control. A “teach-in” function is used to program up to three separate outputs. Contrinex color photoelectric sensors also feature five selectable tolerance levels for each output, enabling the sensor to recognize or ignore even the smallest variations of color.

**Contrast** sensors are ideal for detecting print marks in printing, labelling and packaging processes. Using a narrowly focused light beam and RGB emission technology, contrast sensors automatically select the best emission color (red, green or blue) during the teach-in procedure. Excellent contrast resolution, a high switching frequency (up to 10 kHz) and five tolerance levels ensure accurate detection and positioning, even when contrast differences are minimal. The integral **IO-Link** interface may be used to reduce changeover times through remote teach-in and parameterization. Other control functions, including monitoring, diagnosis and switching timer adjustment are also available (see page 289).

Contrinex color and contrast sensors have a rugged PBTP housing (40 mm x 50 mm x 15 mm) with **IP67** enclosure rating and are available in cable or adjustable (0°, 45° or 90°) connector versions.



## LIGHT GRIDS

### Fast detection, counting and measurement

The use of infrared **light grids** for non-contact measurement offers many advantages, including fast response times, reliable detection of the most varied objects and immunity to interference from ambient light. Potential applications for these keen-eyed, robust sensors are to be found in such fields of application as logistics or automated packaging systems and in harsh environments such as warehouses and the wood industry.

With the **DGI** (detection) and **MGI** (measurement) series, Contrinex presents compact infrared light grids as a robust plug-and-play solution. With a cross-section of only 40 x 20.5 mm, these space-saving devices are easily integrated into different systems. DGI types offer detection heights up to 2010 mm and are capable of detecting objects with diameters

of 0.9, 2, 4, 8 or 25 mm, depending on type. With response times between 0.8 and 4.8 ms, even small objects moving at high speed can be reliably detected and counted. Fields of application include the production of small parts or foil, packaging equipment and the pharmaceutical industry. In addition to detecting the presence of an object, MGI measurement types can also determine its dimensions and position. These sensors offer measurement heights up to 1438 mm and a resolution of 5 or 12 mm. Measurements are output as analog values of 0-10 V or as a 4-20 mA signal.



Inductive

Photoelectric

Safety

RFID

Connectivity

Accessories

Glossary

Index

## IO-LINK FUNCTIONALITY\* WITH PHOTOELECTRIC SENSORS (PNP TYPES)

### Data monitoring:

- 1 Detection status is monitored and continuously transmitted through IO-Link process data. This data contains both the detection state and the stability of detection (sufficient detection margin). It is possible, therefore, to determine whether the sensor is working too close to its detection threshold, for example due to window contamination.

### Diagnosis:

- 2 The operating state of the sensor is checked. In case of wire break, under-voltage, disturbances on the receiver, sensor malfunction or installation of the wrong sensor, information is provided directly through IO-Link to enable fast repair, maintenance and replacement.

### Sensitivity and teach:

- 3 The sensitivity of the sensor can be adjusted remotely by changing the threshold. Alternatively, the teach function can be used to adapt the threshold to the application. Calibrated sensing ranges ensure easy sensor replacement by uploading the existing sensitivity to the replacement sensor.

### Light-on/Dark-on selection:

- 4 The output switching mode can be selected as light-on or dark-on. A single sensor type is configurable for the various needs of an application. This helps reduce the number of different sensor types required in stock.

### Switching timer:

- 5 The timing of output switching can be configured. Depending on the needs of an application, output switching can be delayed or the duration stretched.

### Sensor mode:

- 6 3 different modes are selectable depending on the application needs: "Normal", "Fast" and "Fine". "Normal" mode is a good balance of speed and precision. In "Fast" mode, speed is higher and in "Fine" mode precision is higher.

### Sequence selection:

- 7 For cross-talk immunity with through-beam sensors, up to 9 different emitting sequences can be selected to pair the emitter with the receiver.

### Detection counter:

- 8 Detection events are counted. By registering the number of detections, it is possible to calculate the speed or number of parts. The counter can be reset by means of a unique IO-Link message.

### Temperature:

- 9 The internal temperature of the sensor is measured continuously, which provides an indication about the ambient temperature in the application. Moreover, the maximum temperature measured is saved for diagnosis and preventive maintenance purposes.

\* Functionalities may vary depending on series and sensor type

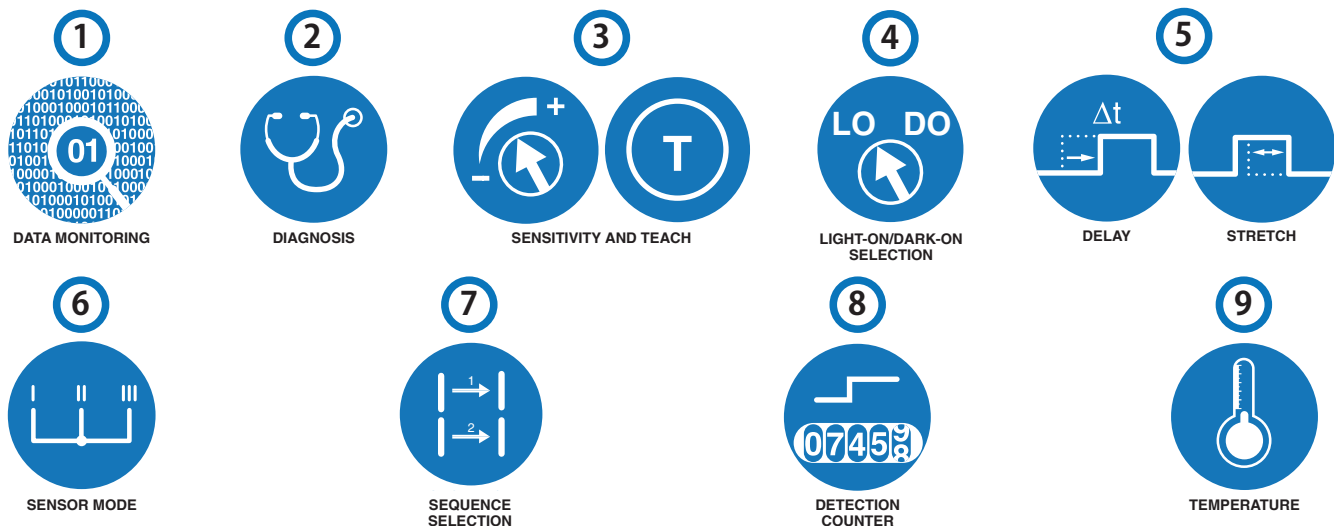



# GLOSSARY

## HIGHLIGHTS:

- ✓ Clearance
- ✓ Connectors
- ✓ Correction factors
- ✓ Degrees of protection
- ✓ EMC
- ✓ Excess gain
- ✓ Hysteresis
- ✓ Mounting
- ✓ Oil resistance
- ✓ Operating distance
- ✓ Parallel connection
- ✓ Switching frequency
- ✓ Tightening torque
- ✓ Turn-on/turn-off time

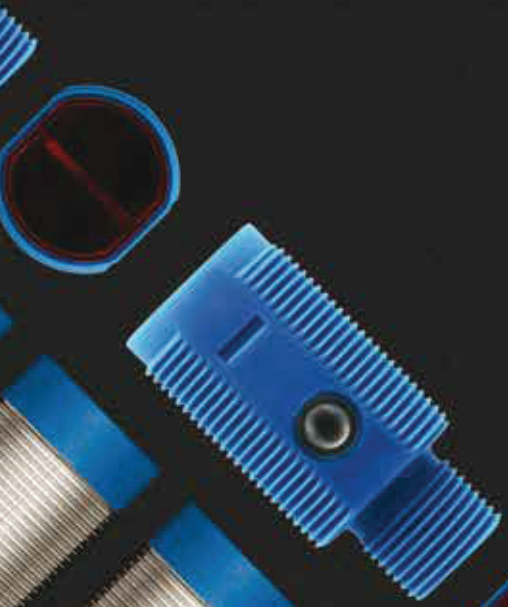

 **INDUCTIVE SENSORS**

 **PHOTOELECTRIC SENSORS**

# A

## ADJUSTMENT (POTENTIOMETER)



The sensitivity is adjusted by means of the built-in single or multi-turn potentiometer (if provided). Turning it clockwise increases the sensitivity. Multi-turn potentiometers cannot be turned over their end position (no stops).

### THROUGH-BEAM SENSORS / REFLEX SENSORS

The potentiometer is normally set to the maximum sensitivity (turned clockwise). This provides the maximum system reserve (excess-gain) signal.

### DIFFUSE SENSORS

Set the sensitivity so that the target is reliably detected; for reliable operation, the green LED should light up, or the yellow LED should not flash (series 1040/1050/0507). On removing the object, if the output remains ON (detection of the background), the sensitivity must be reduced slightly.

### DIFFUSE SENSORS WITH BACKGROUND SUPPRESSION

The setup must ensure that the target is clearly identified, and any background excluded. The target should first be positioned at the maximum foreseen distance from the emitter, and the potentiometer adjusted so that the output just switches. The target is then removed and the potentiometer adjusted so that the background just causes the output to switch. Finally, the potentiometer is set to half way between the two previous readings. Where there is no background, the potentiometer should be set to the maximum distance.

## ALIGNMENT



### THROUGH-BEAM SENSORS

First place the receiver and fix it in its final position. Then align the emitter accurately onto the receiver.

### REFLEX SENSORS

First place the reflector as required and fix it firmly in position. Fit the reflex sensor with the optical axis aligned on the reflector so that it switches reliably. Test with target. Reduce sensitivity if necessary.

### DIFFUSE SENSORS

Align the unit's optical axis with the target so that switching occurs reliably. Check that enough system reserves (excess gain) are available, i.e. the green LED must light up (series 1120, 1180, 1180W, 3030, 3031, 3060, 4040, 4050 and C23). Finally, fix the device firmly.

### DIFFUSE SENSORS WITH BACKGROUND SUPPRESSION

Line up the beam on the center of the target, before fixing the device firmly.



## AMBIENT LIGHT LIMIT



Ambient light is that which is produced by external light sources. The illumination intensity is measured on the light incidence surface. The sensors are basically insensitive to ambient light due to the use of modulated light. There is nevertheless an upper limit for the intensity of any external light and this is referred to as the ambient light limit. It is given for sunlight (unmodulated light) and halogen lamps (light modulated at twice the mains frequency). Reliable operation of the units is no longer possible at light intensities above the relevant ambient light limit.

## AMBIENT TEMPERATURE



The specified ambient temperature range **must not be exceeded** in order to avoid damaging the sensor and rendering its performance unreliable.

## ANALOG OUTPUT



Devices with analog output deliver an analog output signal approximately proportional to the target distance. For most models, voltage and current outputs are available **simultaneously**.

## AUTOCOLLIMATION



Photoelectric sensors using the autocollimation principle are characterized by the fact that the optical axes of the emitting and receiving channels are identical. This is possible with light from one of the channels being deflected by means of a semi-transparent mirror (Fig. 13). This principle completely eliminates the interfering blind zone often found in the proximity of the sensor, which is of special advantage when using reflex sensors.

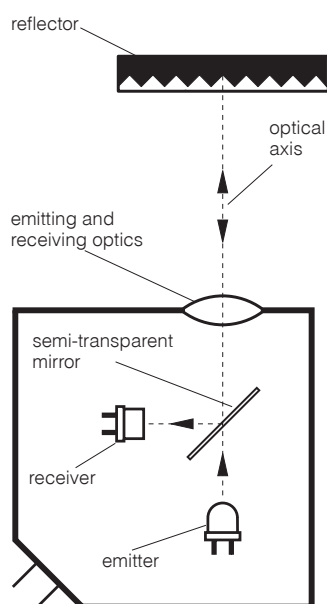

Fig. 13

# B

## BACKGROUND SUPPRESSION



The light pulse from the emitting diode leaves the optical system as a focused, almost parallel, light beam. On meeting an object in its path, part of the beam is diffusely reflected, and in turn, part of this reflected light falls on the PSD (**P**osition-**S**ensitive **D**evice) housed in the same sensor (Fig. 14).

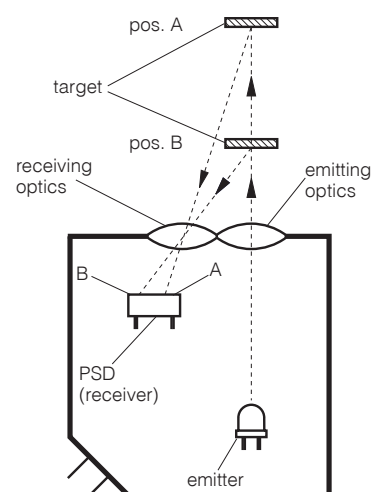

Fig. 14

Depending on the distance of the target from the device, the light falls on a particular spot of the PSD, and a corresponding reception signal is emitted, indicating that an object is present at a certain distance from the device. The analyzing circuit compares the signal received with the preset operating distance (adjusted by means of the built-in potentiometer), and, if the distance of the object is less than, or equal to, the preset operating distance, the output is switched. Contrary to an energetic diffuse sensor, the operating distance depends only to a very small extent on the target's size or color, or on the nature of its surface. The object can therefore be easily discerned, even against a light background.

# C

## CAPACITANCE



The maximum switchable capacitance is the greatest permissible total capacitance at the device's output so that **reliable switching** is still guaranteed. Contributing to this total capacitance in particular are the lead capacitance (approx. 100 ... 200 pF per m) and the load's input capacitance. The value is given in the individual data sheets. These can be found on the Contrinex website ([www.contrinex.com](http://www.contrinex.com)), or ordered from our sales offices.

## CE MARK



All sensors in this catalog meet the requirements of European standards EN 60947-1 and EN 60947-5-2, and therefore correspond to EMC directive 2004/108/EC, as well as low-voltage directive 2006/95/EC. Consequently, they are labeled with the CE mark.

# CE

However, this mark is **neither a quality seal, nor an official test label** certified by any authority. By applying the CE mark, the manufacturer confirms (under his own responsibility) that the protective requirements for the product meet the applicable EU directives, and consequently that the corresponding EU standards have been complied with. The CE mark enables the free importation of goods into the EU, as well as their free circulation within the EU.

## CHANGEOVER



Devices with changeover outputs provide one output for the light-ON or NO signal, and another for the dark-ON or NC signal. Both functions are available simultaneously for maximum connection flexibility to the control unit. Moreover, logical connections may be implemented without using series connection. Connecting both outputs to the control unit allows additional security monitoring.

## CLASSICS FAMILY



The **Classics** family (600 series) is one of three inductive sensing technologies offered by Contrinex. **Classics** family sensors rely on conventional inductive oscillator and coil technology (see page 20).

Sensors are sized from Ø 3 up to M30 and C44 (40 mm x 40 mm). PNP, NPN and 2-wire AC/DC output configurations are available, combined with sensing distances between 0.6 mm and 40 mm.

The **Classics** technology family includes devices from the following ranges: **Basic**, **Miniature**, **2-wire**, **Extra pressure**, **Extra temperature**, **High temperature** and **Washdown**.

## CLEARANCE



Inductive sensors must not mutually influence each other. For this reason, a minimum distance **A** between devices of diameter **D** must be observed (Fig. 15).

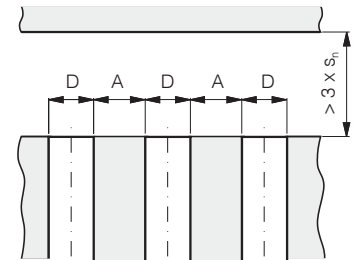

Fig. 15

## EXTRA DISTANCE (SERIES 500, 520\*)

Size D	(quasi)-embed. A (mm)	non-emb. A (mm)
Ø 4	6 (embeddable)	---
M5	5 (embeddable)	---
Ø 6.5	9.5	---
M8	8 / *16	20
C8	8	---
M12	18 / *34	30
M18	26	60
M30	50	120

**CLASSICS (SERIES 600, 620\*)**

Size D	embeddable A (mm)	non-emb. A (mm)
Ø 3	0 / *2	---
M4	0 / *1	---
Ø 4	0 / *1	---
M5	0 / *1	---
C 5	0 / *1	---
Ø 6.5	3 / *3.5	--- / *15.5
M8	2 / *4	10 / *14
C8	2 / *2	---
M12	4 / *12	28 / *33
M18	7 / *22	32
M30	10	50
C44	35	120

**DIFFUSE SENSORS (FIG. 16)**

Series	distance a (mm)
Series 1040 / 50	50
Series 1040 / 50...505	15
Series 1040 / 50...506	30
Series 1120	150
Series 1180 / 1180W	500
Series 3030	500
Series 3031	250
Series 4050	150

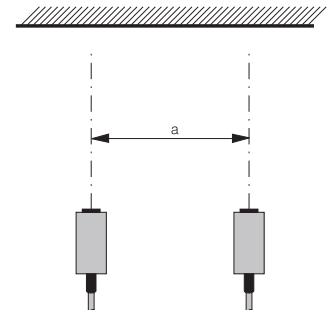

Fig. 16

**FULL INOX (SERIES 700)**

Size D	embeddable A (mm)	non-emb. A (mm)
M8	14	52
M12	38	108
M18	42	182
M30	80	270



Photoelectric sensors must not mutually influence each other. For this reason, a minimum distance “a” between them has to be respected, which depends strongly on the model used and the actual sensitivity setting. The following values should therefore be considered as rough guidelines only. The values given are for maximum sensitivity.

**DIFFUSE SENSORS WITH BACKGROUND SUPPRESSION**

Series	distance a (mm)
Series 1180 / 1180W	50
Series 3130	50
Series 3131	50
Series 4050	100

**REFLEX SENSORS (FIG. 17)**

Series	distance a (mm)
Series 1120	150
Series 1180 / 1180W	250
Series 3030	500
Series 3031	250
Series 4050	200

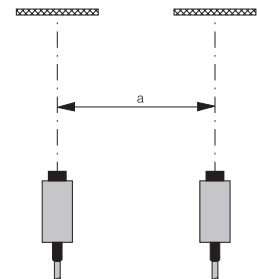

Fig. 17

**THROUGH-BEAM SENSORS (FIG. 18)**

Series	distance a (mm)
Series 1040 / 50	50
Series 1120	150
Series 1180 / 1180W	250
Series 3030	500
Series 3031	250
Series 4050	500

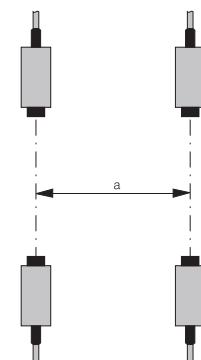

Fig. 18

**FIBER-OPTIC AMPLIFIERS**

The value “a” depends strongly on the specific type of fiber used. General recommendations are therefore not possible.

## CONDET® TECHNOLOGY



An innovative technology for producing inductive sensors. Contrary to conventional technology, in which a high-frequency magnetic field is generated in front of the sensing face, here the coil is triggered by an alternating polarity **pulsed current**. This technology is used in the Full Inox family (700 series) (see also page 20). It permits:

- generally long operating distances
- long operating distances also on non-ferrous metals, such as aluminum, brass, copper, etc.
- **one-piece** stainless steel housing (sensing face included)

## CONDIST® TECHNOLOGY



Developed by Contrinex, this innovative technology makes use of a high-performance oscillator for inductive sensors. Operating distances from **2.2 to 4 times** the standard values are possible thanks to excellent temperature and voltage stability. Devices of the Extra distance family (500 and 520 series) work with such an oscillator (see also page 21).

## CONNECTORS



### PIN ASSIGNMENT SIZE S8:

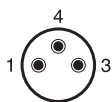

*NO and NC*

+U <sub>B</sub>	pin 1	brown
0V	pin 3	blue
output	pin 4	black

### NAMUR

L+	pin 1	brown
L-	pin 4	blue

*Analog output*

+U <sub>B</sub>	pin 1	brown
0V	pin 3	blue
voltage output	pin 4	black

### PIN ASSIGNMENT SIZE S12:

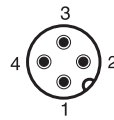

*NO*

+U <sub>B</sub>	pin 1	brown
0V	pin 3	blue
output	pin 4	black

*NC*

+U <sub>B</sub>	pin 1	brown
0V	pin 3	blue
output	pin 2	white

*2-wire DC / NO*

L-	pin 3	brown
L+	pin 4	blue

*2-wire DC / NC*

L-	pin 1	brown
L+	pin 2	blue

*Analog output*

+U <sub>B</sub>	pin 1	brown
0V	pin 3	blue
voltage output	pin 4	black
current output	pin 2	white

### PIN ASSIGNMENT SIZE 1/2":



*2-wire AC/DC / NO and NC*

L1	pin 3	blue
L2	pin 2	brown
GND	pin 1	yellow/green



### PIN ASSIGNMENT SIZE S8 3 POLE:

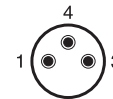

*NO and NC*

+U <sub>B</sub>	pin 1	brown
0V	pin 3	blue
output	pin 4	black

### PIN ASSIGNMENT SIZE S12 3 POLE:

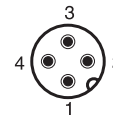

*NO*

+U <sub>B</sub>	pin 1	brown
0V	pin 3	blue
output	pin 4	black

*NC*

+U <sub>B</sub>	pin 1	brown
0V	pin 3	blue
output	pin 2	white

## PIN ASSIGNMENT SIZE S12 5 POLE:

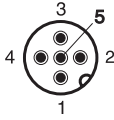

NO and NC

+U <sub>B</sub>	pin 1	brown
output 2	pin 2	white
OV	pin 3	blue
output 1	pin 4	black
test	pin 5	gray

## PIN ASSIGNMENT SIZE S8 4 POLE:



NO and NC

+U <sub>B</sub>	pin 1	brown
output 2	pin 2	white
OV	pin 3	blue
output 1	pin 4	black

Teach

+U <sub>B</sub>	pin 1	brown
output 2	pin 2	white
OV	pin 3	blue
output 1	pin 4	black

## PIN ASSIGNMENT SIZE S12 4 POLE:

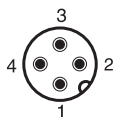

NO and NC

+U <sub>B</sub>	pin 1	brown
output 2	pin 2	white
OV	pin 3	blue
output 1	pin 4	black

## CORRECTION FACTORS



The specified operating distance **s** of inductive sensors refers to exactly defined measuring conditions (see **OPERATING DISTANCE**).

Other arrangements generally result in a reduction of the operating distance. The following data are to be considered as **guidelines** only; according to size and version, there can be wide variations. Exact values are given in the individual data sheets. These can be found on the Contrinex website ([www.contrinex.com](http://www.contrinex.com)), or ordered directly from our sales offices.

### CLASSICS (SERIES 600 / 620)

Material influence (indicative values):

Target material	Operating distance
Steel type FE 360	$s_n \times 1.00$
Aluminum	$s_n \times 0.55$
Brass	$s_n \times 0.64$
Copper	$s_n \times 0.51$
Stainless steel (V2A)	$s_n \times 0.85$

Geometrical influence:

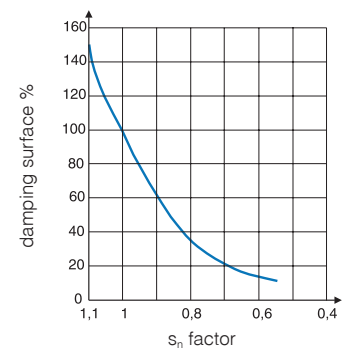

When using foils, an increase in the usable operating distance can be expected.

### EXTRA DISTANCE (SERIES 500 / 520\*)

Material influence (indicative values):

Target material	Operating distance
Steel type FE 360	$s_n \times 1.00$
Aluminum	$s_n \times 0.36 / *0.28$
Brass	$s_n \times 0.44 / *0.37$
Copper	$s_n \times 0.32 / *0.24$
Stainless steel (V2A)	$s_n \times 0.69$

Geometrical influence:

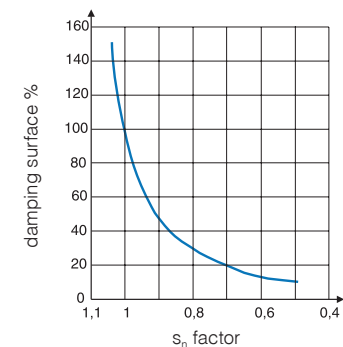

When using foils, an increase in the usable operating distance can be expected.

## FULL INOX (SERIES 700)

Material influence (indicative values):

Target material	Operating distance
Steel type FE 360	$s_n \times 1.0$
Aluminum	$s_n \times 1.0$
Brass	$s_n \times 1.3$
Copper	$s_n \times 0.8$
Stainless steel (1 mm thick)	$s_n \times 0.5$
Stainless steel (2 mm thick)	$s_n \times 0.9$

Geometrical influence:

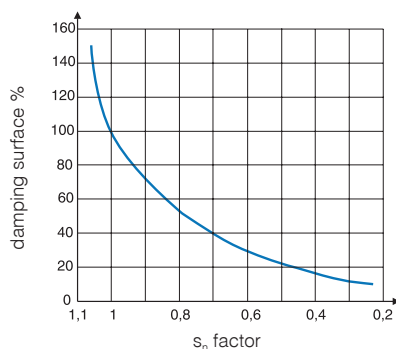

When using foils, a **decrease** in the usable operating distance can be expected.



Test card (Kodak paper, white)	100%
Paper, white	80%
PVC, gray	57%
Newspaper, printed	60%
Wood, lightly colored	73%
Cork	65%
Plastic, white	70%
Plastic, black	22%
Neoprene, black	20%
Automobile tires	15%
Aluminum sheet, untreated	200%
Aluminum sheet, black anodized	150%
Aluminum sheet, matt (brushed finish)	120%
Stainless steel, polished	230%

The specified sensing ranges of energetic diffuse sensors are achieved using standard matt white paper of the specified dimensions as the target surface. For other target surface materials, the correction factors listed here apply (these are guideline values only).

## D

### DARK-ON



The “dark-ON” function means that the relevant output is switched (carrying current) when **no** light is reaching the receiver.

### DEGREES OF PROTECTION



The IP degrees of protection are defined in DIN 40050 / IEC 60529. The meaning of the **first numeral** is:

**6** The housing provides complete protection against contact with electrically conducting or moving parts, and full protection against dust penetration.

and the **second numeral**:

**4** Protection against water splashes: water splashed against the housing from any direction must have no harmful effect.

**Test conditions:** spraying with oscillating tube or spray nozzle; water pressure 1 bar; delivery rate 10 l/min  $\pm$  5%; duration 5 minutes.

**5** Protection against water jets: water projected by a nozzle from any direction under specified conditions must have no harmful effect.

**Test conditions:** nozzle with 6.3 mm diameter; delivery rate 12.5 l/min  $\pm$  5%; distance 3 m; duration 3 minutes.

**7** Protection against water when device is immersed in water under specified pressure and time conditions. Water must not penetrate in damaging quantities.

**Test conditions:** immersion depth in water 1 m; duration 30 minutes.

**8** Protection against water when device is immersed in water indefinitely under specified pressure conditions. Water must not penetrate in damaging quantities.

**Test conditions** used by Contrinex: immersion depth in water 5 m; duration  $\geq$  1 month.

**9K** Protection against water which, if directed against the housing from any direction and under considerably increased pressure, must have no harmful effect.

**Test conditions:** sensor mounted on table turning at  $5 \pm 1$  rpm; spraying with flat nozzle; delivery rate 14 - 16 l/min; distance 100 - 150 mm; angles 0°, 30°, 60° and 90°; temperature  $80 \pm 5^\circ\text{C}$  ( $176 \pm 41^\circ\text{F}$ ); pressure 8,000 - 10,000 kPa (80 - 100 bar / 1160.8 - 1451 psi); duration 30 sec per position.

Devices with degree of protection **IP 67** are thus **not intended for prolonged operation in water**, or in prolonged humid conditions. Tolerance to liquids other than water must be examined from case to case.

# E

## EMBEDDABLE MOUNTING



See **MOUNTING**.

## EMC



The EMC (**E**lectromagnetic **C**ompatibility) resistance of the devices satisfies the highest demands. For exact values, please refer to the data sheets.

All devices comply with the EU directive no. 2004/108/EC. In addition, they undergo severe field testing.

## EXCESS-GAIN INDICATION (SYSTEM RESERVE INDICATION)



The excess-gain indication circuit detects the excess radiation power which falls on the light incidence surface and is processed by the light receiver. The excess gain can decrease in time due to dirt, a change in the target's reflection factor, and aging of the emitter diode, so that reliable operation can no longer be guaranteed. Some devices are therefore equipped

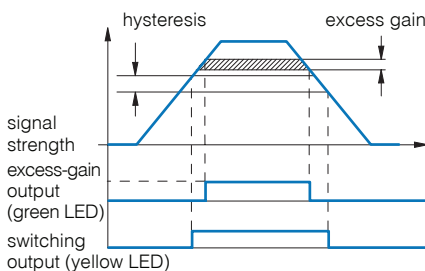

Fig. 19

with a second LED (green), which lights up when less than approximately 80% of the available operating distance is used. Models with an excess-gain output make the excess-gain signal available to the user for further processing. Thus, operating conditions which are no longer reliable can be recognized in time.

## EXTRA DISTANCE FAMILY



The **Extra Distance** family (series 500/520) is one of three inductive sensing technologies offered by Contrinex. **Extra Distance** family sensors rely on conventional inductive oscillator and coil technology, but with a completely different signal evaluation circuit for better stability and therefore **long operating distances**. The most important contribution to this comes from the Contrinex Condist® oscillator (see pages 20-21).

Sensors are sized from Ø 4 to M30, with long operating distances up to 40 mm.

The Extra Distance technology family includes devices from the **Basic, Miniature, Extra pressure, High pressure** and **Analog output** ranges.

# F

## FULL INOX FAMILY



The **Full Inox** family (series 700) is one of three inductive sensing technologies offered by Contrinex. **Full Inox** family sensors rely on Contrinex's patented Condet® technology (see page 21).

**Full Inox** sensors have a one-piece, stainless steel housing and are exceptionally robust and chemically resistant. They are not only the most durable inductive sensors on the market, but also offer long operating distances on any conductive metal.

Sensors are sized from Ø 4 to M30 and cuboid variant of 20 x 32 x 8 mm, with long operating distances up to 40 mm and protection class IP 67 and IP 69K

The **Full Inox** technology family includes devices from the **Basic, Miniature, Extreme, High pressure, Washdown, Weld-immune, Chip-immune, Double-sheet** and **Maritime** ranges.

# H

## HYSTERESIS



Hysteresis (differential travel) causes a defined switching behavior of the device (Fig. 20). The sensing range always refers to the switch-on point.

Distance hysteresis is only useful for the diffuse sensor model and its related fiber version.

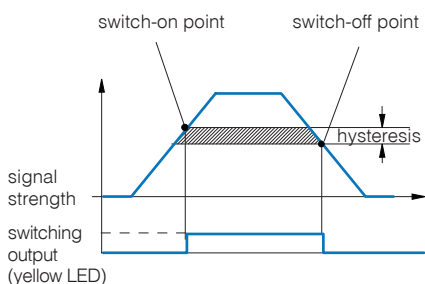

Fig. 20



Hysteresis (differential travel) causes a defined switching behavior of the device (Fig. 21). The operating distance always refers to the switch-on point. Namur devices and those with analog output have continuous transmission behavior, i.e. there is no hysteresis.

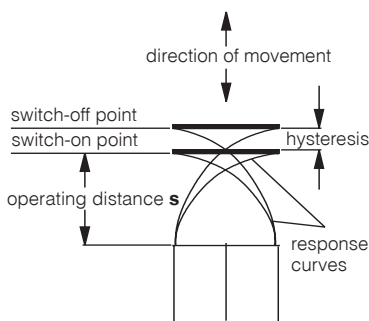

Fig. 21

# I

## INDUCTION PROTECTION



When inductive loads are switched off, the output voltage, without a protective circuit, would increase to a high value, which could destroy the output transistor. Contrinex sensors therefore contain a **Zener diode** at the output to limit the switch-off voltage to a safe value (3-wire types). When connecting an inductive load with a current >100 mA and simultaneously a switching frequency >10 Hz, the mounting of a **free-wheeling diode** directly to the load is recommended (due to the leakage power in the built-in Zener diode).

## INSTALLATION



Photoelectric sensors can be easily and reliably installed in any position, using the mounting accessories supplied with most devices. The installation position should preferably protect the units against dirt and other contamination.



For inductive sensors, see [MOUNTING](#).

## INSULATION VOLTAGE



The devices in this catalog are designed for an insulation voltage (between connecting leads and housing) of 75 VDC / 50 VAC (for supply voltages up to 75 VDC / 50 VAC) or 300 VDC / 250 VAC (for supply voltages between 75 VDC / 50 VAC and 300 VDC / 250 VAC).

## IP 64 / IP 65 / IP 67 / IP 68 / IP 69K



Refer to [DEGREES OF PROTECTION](#).



## IR LIGHT



IR is the abbreviation of “**Infra-Red**”. This refers to any electromagnetic radiation with a wavelength exceeding that of normal visible light, which is approx. 380 to 780 nm. Wavelengths of approx. 780 to 1500 nm are typically used. IR light cannot be used with synthetic fibers, due to high attenuation. Instead, visible red light is used. As the usual polarization filters cannot be used in the IR range, visible red light is also used for reflex sensors.



## LEAD LENGTHS



For the sensor, long leads mean:

- a capacitive load at the output (see **CAPACITANCE**)
- increased influence of interference signals

Even under favorable conditions, lead lengths should not exceed **300 m**.

## LEADS



The standard built-in leads are **not** suitable for **repeated bending stresses**. In such cases, high-flexibility PUR cables (special executions) or connectors with corresponding connecting cables (see pages 441-449) must be used.

## LEAKAGE CURRENT



Leakage current is the current that flows through the output transistor and thereby through the load when the output is OFF (to be taken into account particularly where switches are connected in parallel).

## LED



Most of the inductive devices in this catalog are equipped with a built-in yellow light-emitting diode (LED). It indicates the switching state: **output activated = yellow LED on**.



All photoelectric sensors have one or two **Light Emitting Diodes (LEDs)** built in. The yellow LED lights up when the output is switched (for switches with 2 outputs: the light-ON output). During a short-circuit or overload, the yellow LED does not operate. The green LED (if provided) lights up when enough system reserves (excess gain) for reliable operation are available, i.e. when an object is present in the reliable sensing area (diffuse sensors), or when enough light from the uninterrupted beam reaches the receiver (reflex and through-beam sensors).

## LIGHT-ON



Light-ON means that the relevant output is switched (carrying current) when light is reaching the receiver.

## LOAD RESISTANCE



From the selected supply voltage  $U_b$  and the specified maximum output current of the sensor, the lowest permissible load resistance for trouble-free operation can be calculated.

Example: With a voltage of 24 V and a specified maximum permissible output current of 200 mA, the minimum load resistance is 120 ohm; at 15 V, it is 75 ohm.

# M

## MAGNETIC FIELDS



**Strong fields** can saturate the ferrite core of inductive sensors, thereby increasing the operating distance, or even provoking false switching. However, no lasting damage is caused. **High-frequency fields** of several kHz (700 series), or several hundred kHz (other series), may seriously interfere with the switch functioning, since the oscillator frequency of the devices lies in this range. If difficulties with interfering magnetic fields are encountered, shielding is recommended.

## MODULATED LIGHT



The photoelectric sensors listed in this catalog operate with modulated light, i.e. the light emitter is switched on only for a short period and remains switched off for much longer (ratio approx. 1:25). In diffuse and reflex sensors, the receiver is only active during the light pulse, and is disabled during the pulse gap. Operation with modulated light provides the following advantages:

- The devices are largely insensitive to ambient light
- Longer sensing ranges are possible
- Heat generation is reduced, which prolongs the operating life of the emitting diodes

## MODULATION FREQUENCY



The photoelectric devices in this catalog are operated with modulated light, which makes them largely insensitive to ambient light. The modulation frequency  $f_{cy}$  is in the range of several kHz.

If a device is operated in the proximity of another device with the same modulation frequency, interference can occur.

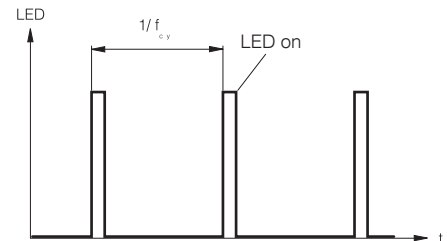

Fig. 22

## MOUNTING



For photoelectric sensors, see [INSTALLATION](#).



## EMBEDDABLE SENSORS

Embeddable sensors may be flush mounted in all metals. For trouble-free operation, a free zone according to Fig. 23 should be observed.

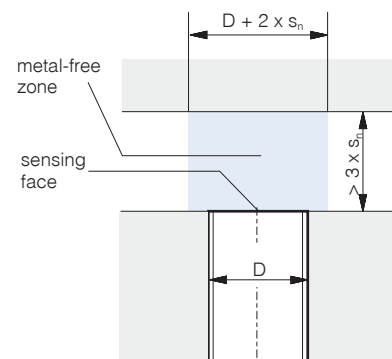

Fig. 23

## QUASI-EMBEDDABLE SENSORS

When installing quasi-embeddable Extra Distance sensors (500 and 520 series) in conductive materials (metals), the devices must **protrude** by a distance **X**, according to Fig. 24. Further, a free zone of  $3 \times s_n$  must be observed. Flush mounting in non-conducting materials is permitted.

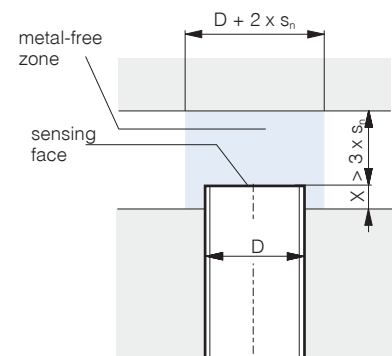

Fig. 24

Mounting in steel and in non-ferrous metals:

Housing size D	X (mm)
Ø 6.5	1
C8	1
M12	2
M18	4
M30	6

Mounting in stainless steel:

Housing size D	X (mm)
Ø 6.5	0.0
C8	0.0
M12	1.0
M18	1.5
M30	2.0

## NON-EMBEDDABLE SENSORS

When mounting non-embeddable sensors in conducting materials (metals), minimum distances to the conducting material must be maintained according to Fig. 25. Flush mounting in non-conducting materials is permitted.

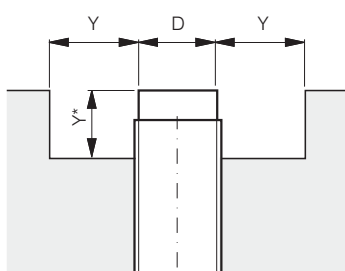

Fig. 25

Housing size D	Y (mm)
M8	8
M12	12
M18	22
M30	40
C44	60 / *40

# N

## NC



The output is closed when the switch is not activated. It is open when the switch is activated.

## NO



The output is open when the switch is not activated. It is closed when the switch is activated.

## NO-LOAD SUPPLY CURRENT



No-load supply current is understood as the inherent consumption of the sensor for operating the LED, amplifier, etc., in the non-activated state. It does not include the current flowing through the load.

## NON-EMBEDDABLE MOUNTING



See **MOUNTING**.

## NPN CONFIGURATION



The output device contains an NPN transistor, which switches the load towards zero voltage. The load is connected between the output terminal and the positive supply voltage  $+U_B$  (Fig. 26).

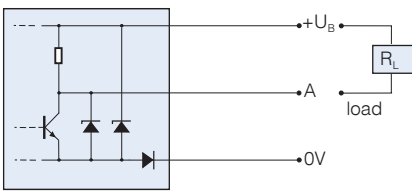

Fig. 26



## OIL RESISTANCE



Long-term contact with any oils may affect plastics and weaken their resistance. However, inductive Full Inox sensors (series 700), as well as the sealed (series E) and high-pressure-resistant (series P) types can be used in **oily environments** without restriction. For all other types, this is not necessarily the case.

Thus, please observe the following:

### Lubricating oils:

Generally cause no problems. Use versions with oil-resistant PUR cable (special executions).

### Hydraulic oils, cutting oils:

These attack most plastics. In particular, PVC cables discolor and become brittle. Measures:

- Wherever possible, avoid contact with these liquids, particularly at the sensing face.
- Use versions with oil-resistant PUR cable.



For photoelectric sensors, housing, optical unit, and cable should be considered separately:

### Housing

The PBTP / polybutyleneterephthalate (Crastin®) used for the housing is highly resistant to all conventional types of oil, in particular, to cutting and hydraulic oils, as well as drilling emulsions.

### Optics

The windows are generally of glass (with the exception of series 4150 and 5050), and are therefore not affected. However, oil on the light in- and outputs changes their optical properties. The effects should be examined from case to case.

### Cable

The PVC cable used as standard is not resistant to most types of oil, and becomes brittle in long-term use. The optional PUR cable should therefore be used in oily environments.

## OPERATING DISTANCE



The operating distance of inductive sensors is the distance at which a target approaching the sensing face triggers a signal change. The operating distance is measured according to IEC 60947-5-2 / EN 60947-5-2, using a **standard square target** moving axially (Fig. 27). This target is made of steel, e.g. type FE 360 in accordance with ISO 630, with a smooth surface, square shape, and thickness of 1 mm (Fig. 28). The sides equal the **diameter** of the inscribed circle of the sensing face or **three times the rated operating distance  $s_n$**  of the sensor, whichever is the greater.

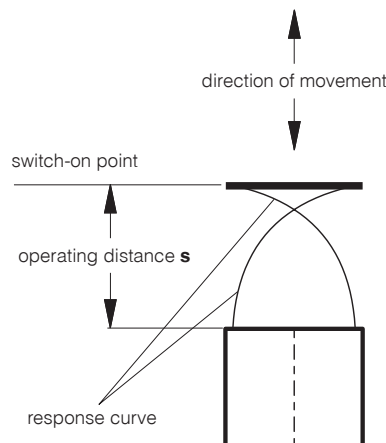

Fig. 27

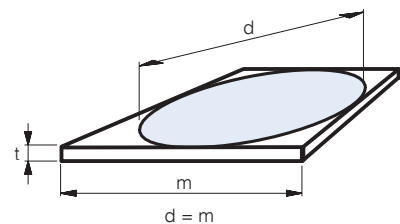

Fig. 28

### Rated operating distance $s_n$

This is the operating distance for which the sensor is designed. It can be found under "technical data".

### Effective operating distance $s_r$

The measured operating distance for a given switch according to IEC 60947-5-2 / EN 60947-5-2.

$$0.9 s_n \leq s_r \leq 1.1 s_n$$

This means that the manufacturing tolerance must not exceed  $\pm 10\%$ .

### Usable operating distance $s_u$

This distance takes into account expected additional deviations caused by temperature and supply voltage fluctuations within the specified range.

$$0.9 s_r \leq s_u \leq 1.1 s_r$$

The temperature and supply voltage ranges can be found under "technical data".

### Assured operating distance $s_a$

$$0 \leq s_a \leq 0.81 s_n$$

This operating distance is guaranteed by the manufacturer for all specified operating conditions. It is the **basis for a safe design**.



See **SENSING RANGE**.

## OPTICAL FIBERS



An optical fiber can consist of a bundle of glass fibers, or one or more synthetic fibers. It is used to conduct light from one place to another, even around bends and curves. This is possible thanks to the phenomenon of total reflection. Total reflection always occurs when light coming from a material with a higher refractive index falls on an interface with a medium having a lower refractive index, in such a way that the critical angle required for total reflection is never reached.

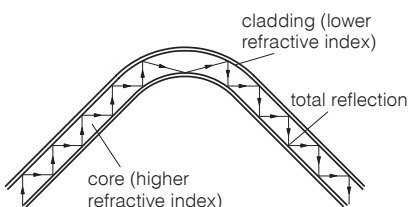

Fig. 29

The fibers consist of a core (with a higher refractive index) and a cladding (with a lower refractive index). Due to total reflection, the light is reflected backwards and forwards in the core, and can thus go round bends and curves.

## OUTPUT CURRENT



The devices are designed for a given maximum output current. If this current is exceeded, even for only a short time, the **overload protection** trips. Incandescent lamps, capacitors, and other heavily capacitive loads (e.g. long leads) have a similar effect to overload (see also **CAPACITANCE**).

## OUTPUT RESISTANCE



In order that the output voltage, even without external load, follows the switching state, Contrinex sensors contain a built-in output resistance (pull-up or pull-down resistor). For operation at high switching frequencies, an additional external load resistor must be added (to reduce the electrical time constant).

## OVERVOLTAGE PROTECTION



For maximum operating reliability and ease of use, Contrinex sensors feature a built-in protection circuit against very short, non-periodic supply voltage peaks, which complies with the requirements of IEC 60947-5-2.

# P

## PARALLEL CONNECTION



Connecting sensors in parallel, in order to perform logic functions, is possible without any problem (Figs. 30 and 31).

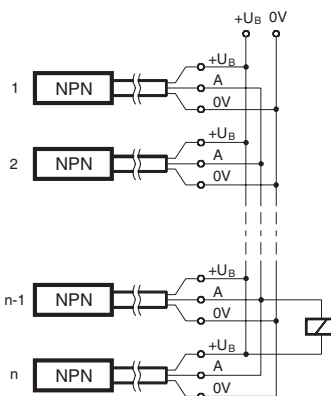

Fig. 30

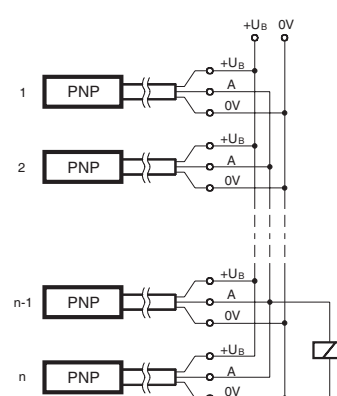

Fig. 31

Please note:

- The no-load supply current increases.
- Leakage currents add up, so that, even when closed, an inadmissible voltage drop can occur at the output.

## PNP CONFIGURATION



The output device contains a PNP transistor, which switches the load towards the positive supply voltage  $+U_B$ . The load is connected between the output terminal and the negative supply voltage  $0V$  (Fig. 32).

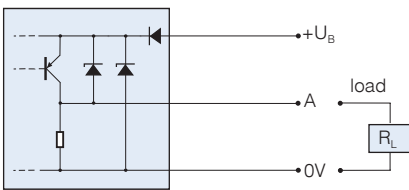

Fig. 32

## POLARITY REVERSAL PROTECTION



Virtually all sensors in this catalog are protected against **any polarity reversal** at all terminals.

## POLARIZATION FILTER

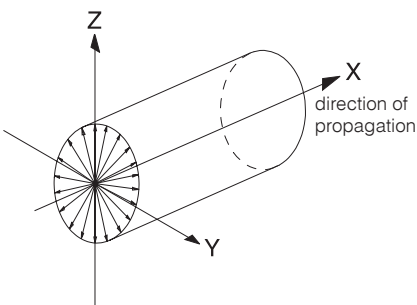

Fig. 33

Natural light (including the light from the emitter diodes) is not polarized (Fig. 33). When light has passed through a polarizing filter however, only that part of the original light which oscillates in the filter polarization direction is still present (Fig. 34). Polarization is retained after reflection by mirrored surfaces, only the direction of polarization may be altered. Diffuse reflection, on the other hand, destroys polarization. This difference can be used to suppress the disruptive effects caused by mirrored surfaces, by means of selection and configuration of suitable filters.

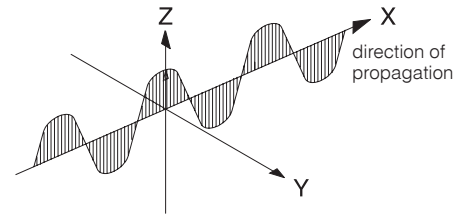

Fig. 34

## POWER-ON RESET



When switched on, the sensor output is activated for a short time due to physical reasons, even without the presence of a target in front of the sensing face. Sensors with power-on reset therefore include an additional circuit that closes the output for a short time during the switching-on phase, so suppressing an error signal (this function is also known as "switch-on pulse suppression").

## POWER SUPPLY UNITS



Circuit recommendations for suitable power supply units are shown in Figs. 35 and 36.

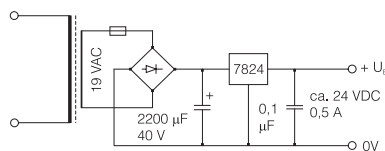

Fig. 35

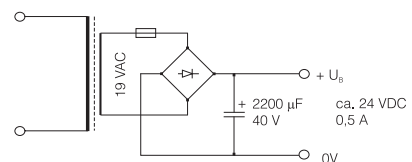

Fig. 36

The Contrinex accessory program also includes a suitable power supply unit (see page 455).

Please observe:

- Unsuitable power supply units are the most frequent reason for sensor problems!
- A transformer and rectifier are not sufficient; at least a smoothing capacitor is essential (due to the ripple content).
- Transformers with a 24 V output, rear-position rectifier and smoothing capacitor deliver a no-load voltage of well above 30 V. Consequently, devices with a maximum supply voltage of 30 V can be damaged.

# R

## REFLECTORS



By means of built-in polarization filters, polarized reflex sensors are designed so that they respond only to the light reflected from special reflectors. These operate according to the principle of the 3-way mirror (Fig. 37). The choice of the correct reflector for a specific application is determined by the required operating distance and installation possibilities. The reflector must be installed perpendicularly to the optical axis (tolerance  $\pm 15^\circ$ ).

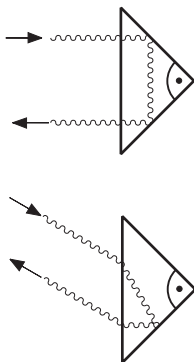

Fig. 37

## REPEAT ACCURACY



Repeat accuracy (according to IEC 60947-5-2/EN 60947-5-2) is understood to be the repeat accuracy of the effective operating distance  $s_r$ , over an 8-hour period at an ambient temperature of  $23 \pm 5^\circ\text{C}$  ( $73.4 \pm 41^\circ\text{F}$ ) and with a specified supply voltage  $U_B$ . The specified repeat accuracy refers to this definition. Successive measurements made immediately one after the other generally lead to much better repeat accuracy.

## RESPONSE DIAGRAM



The specified values for the operating distance refer to an **axial** approach of the target. For staggered or lateral movements, type-specific response curves are valid. Two typical examples are shown below (Fig. 38 and Fig. 39):

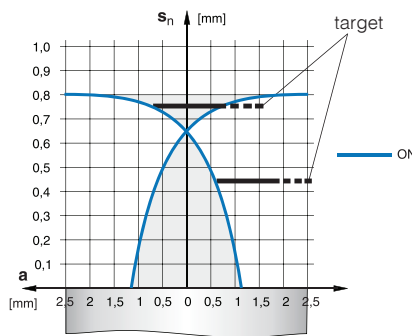

Fig. 38 DW-AD-603-M5

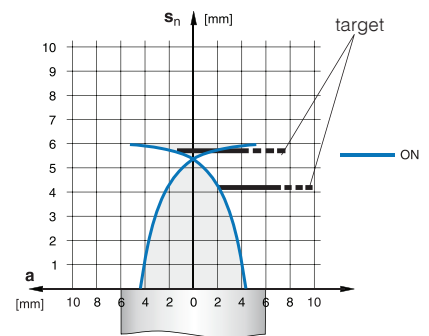

Fig. 39 DW-AD-503-M12

Depending on series, size, and mounting type (embeddable or non-embeddable), the response diagrams differ. Response diagrams for switch types not shown here are readily available from the corresponding individual data sheets. These can be found on the Contrinex website ([www.contrinex.com](http://www.contrinex.com)), or ordered from our sales offices.

## RIPPLE CONTENT



Too much ripple content causes undefined switching behavior. To remedy this, use a larger smoothing capacitor, or a stabilized power supply unit. The specified maximum supply voltage  $U_B$  must not be exceeded, not even during  $U_{SS}$  peaks.

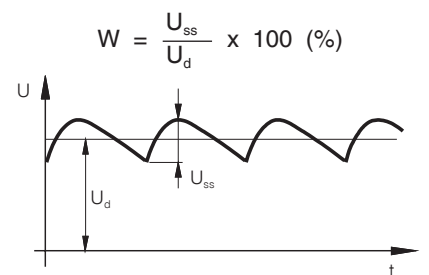

Fig. 40

# S

## SAFETY



The devices in this catalog have not been designed for safety-relevant use. In cases where the safety of people is dependent on their functioning, it is the user's responsibility to ensure that the relevant standards, in particular ISO 13849-1, and regulations are complied with. Contrinex assumes no liability for personal injury.

## SENSING RANGE



The specified sensing range of photo-electric sensors is the maximum usable distance between the device and the standard target (diffuse sensors); between the device and the reference reflector (reflex sensors), and between the emitter and the receiver (through-beam sensors). The potentiometer must be set for maximum sensitivity, or for diffuse sensors with background suppression, for maximum sensing range. Moreover, the specified reflector (reflex sensors) or standard target (diffuse sensors) must be used.

## SERIES CONNECTION



The connection of sensors in series in order to achieve logic functions is possible, but not recommended. The same effect can be achieved by the **parallel connection** of sensors with **NC function** (instead of the series connection of models with NO function), or vice versa. However, please note that, as a result, the output signal is inverted.

## SHOCK RESISTANCE



The sensors in this catalog are tested for resistance to a shock of 30 g (30 times gravitational acceleration) for a period of 11 ms, according to IEC 60068-2-27.

## SHORT-CIRCUIT PROTECTION



The devices in this catalog feature built-in pulse protection against short-circuits and overloads, which alternately closes and opens the output when the maximum output current is exceeded, until the short-

circuit is eliminated. Short-circuits between the output and the supply voltage terminals do not damage the sensor, and are allowed in permanence. The same applies to overloads. During short-circuits, the LEDs do not function.

## SPHERICAL OPTICS



Spherical lenses are special versions of double convex lenses. They feature a short focal length and a good light incidence area. Fig. 41 shows such a design in sensor type LT#-1040/1050-30#-50# (see pages 229-235).

For diffuse sensors, the sphere is cut in two to separate the reception from the emission channel.

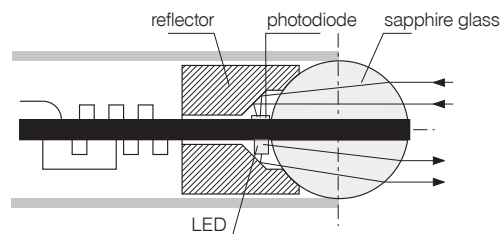

Fig. 41

The emitter and receiver chips are mounted as closely as possible to the surface of the sphere and slightly off the optical axis (see Fig. 41). This causes the emitted beam to intersect the receiver's sensing range at a specific distance from the device, resulting in a relatively short sensing range, but a virtually cylindrical detection zone. A cylindrical detection zone is particularly useful in some applications, such as the detection of targets through narrow holes or gaps.

## STANDARDS



The sensors in this catalog comply, either completely or to a great extent, with the following standards:

- IEC 60947-5-1, **IEC 60947-5-2**, EN 60947-5-1, **EN 60947-5-2**
- IEC 61000-4-1, 61000-4-2, 61000-4-3, 61000-4-4, DIN EN 55011, DIN EN 55081-2, DIN EN 50140
- IEC 60529 / DIN 40050
- IEC 60947-1 / EN 60947-1 / DIN VDE 0660, part 100, part 100 A3, part 200, part 208
- DIN EN 50008, 50010, 50025, 50026, 50032, 50036, 50037, 50038, 50040, 50044



## SUPPLY VOLTAGE $U_B$



The specified maximum supply voltages must **not be exceeded**. For maximum operating reliability and ease of use, Contrinex sensors contain a built-in protection circuit against very short, non-periodic, supply voltage peaks, which complies with the requirements of IEC 60947-5-2. Operating voltages below the lower specified limit, even for short periods, do not damage the switches, but impede their operation.

## SWITCHING FREQUENCY



The maximum switching frequency of inductive sensors indicates the highest permissible number of pulses per second for a constant pulse/pause ratio of 1 : 2 at **half the rated operating distance  $s_n$** . Measurement is according to IEC 60947-5-2 / EN 60947-5-2 (Fig. 42).

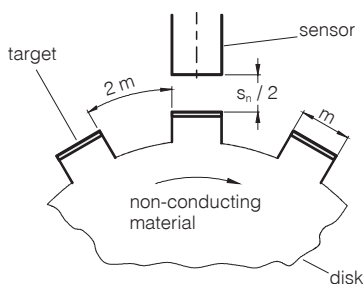

Fig. 42



In the case of photoelectric sensors, the frequency of operating cycles ( $f$ ) is determined from the formula:

$$f = \frac{1}{t_{on} + t_{off}}$$

where:

$t_{on}$  is the turn on time

$t_{off}$  is the turn off time

$t_{on}$  and  $t_{off}$  are measured in accordance with IEC60947-5-2 2007 paragraph 8.5.3. (see also **Turn-on/turn-off time**, in this glossary).

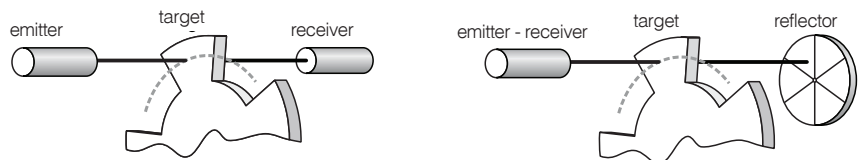

Fig. 43: Through-beam and reflex modes: the light beam must be fully broken by the target.

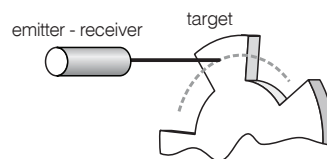

Fig. 44: Diffuse mode: the target must be of the same material as the standard target.

## T

### TEACH-IN



Some devices have a teach-in capability instead of a potentiometer to adjust their sensing range, etc. Teach-in is achieved either directly by pressing a button or remotely via IO-Link.

### TEMPERATURE DRIFT



The set sensing ranges are subject to slight temperature influences. Due to built-in temperature compensation, this effect is much less important for devices of the 4040 series (approx. 0.1 % / °C) than for the other switches (approx. 0.3 % / °C). The sensing range, as a function of ambient temperature, follows approximately the curves shown in Fig. 45.

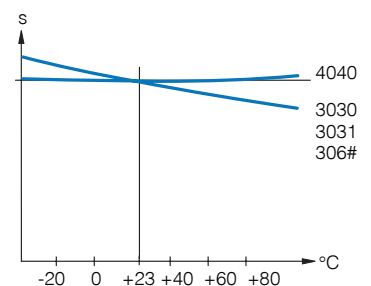

Fig. 45



The specified operating distances refer to a nominal ambient temperature of 23°C (73.4°F). The operating distance, as a function of ambient temperature, follows approximately the curve shown in Fig. 46.

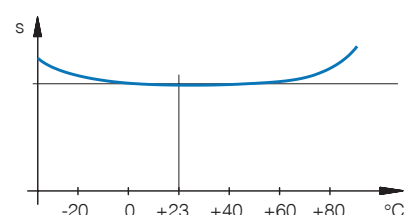

Fig. 46

The temperature of the target itself has practically no influence on the operating distance. Within the permitted temperature range of, as a rule, -25°C to + 70°C (-13°F to + 158°F), the operating distance varies by a maximum of ± 10% compared to its value at 23°C (73.4°F).

## TURN-ON / TURN-OFF TIME



The output **turn-on** time  $t_{on}$  is the minimum period of time required for a sensor to detect the **presence** of a light beam and output an ON signal.

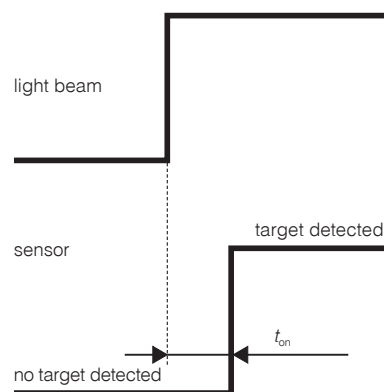

Fig. 47: Output turn-on time

The output **turn-off** time  $t_{off}$  is the minimum period of time required for a sensor to detect the **absence** of a light beam and output an OFF signal.

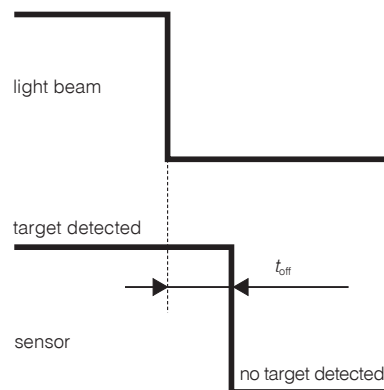

Fig. 48: Output turn-off time

$t_{on}$  and  $t_{off}$  are measured in accordance with IEC60947-5-2 2007 paragraph 8.5.3.

## TEST INPUT



The emitters of through-beam sensors are provided with a test input. Light emission can be switched on and off by means of this input, which, together with the corresponding evaluation of the receiver reaction, permits very efficient sensor monitoring.

## TIGHTENING TORQUE



Over-tightening of the nuts can mechanically damage cylindrical sensors. The specified maximum permissible tightening torques must therefore not be exceeded.



### FULL INOX (SERIES 700)

Housing size D	M (Nm)
M8	8
M12	20
M18	50
M30	150



### SERIES 1040 / 50, 1120, 1180, 1180W

Housing size D	M (Nm)
M5	1.5
M12	10
M18 / M18W	20



### CLASSICS / EXTRA DISTANCE (SERIES 500\*, 520\*, 600, 620)

Housing size D	M (Nm)
M4	0.8
M5	1.5
C5	0.2
M8	8 / *4
C8	1
M12	10**
M18	25
M30	70
C44	2.5

\*\* 6 Nm for the first 10 mm

## TIME DELAY BEFORE AVAILABILITY



The time delay before availability is the maximum time the sensor requires for **operating readiness** after the supply voltage has been switched on.

# V

## VIBRATION RESISTANCE



The sensors in this catalog are tested for resistance to vibrations of 1 mm amplitude at 55 Hz, according to IEC 60068-2-6.

## VOLTAGE DROP



In the switched-through condition, a (current dependent) voltage drop develops across the output transistor; the output voltage, therefore, does not entirely reach the corresponding supply voltage (to be particularly taken into account with series connection and electronic inputs).

# W

## WIRE-BREAK PROTECTION



All sensors in this catalog are equipped with wire-break protection. If a voltage supply lead breaks, the output is disabled, thus avoiding an error signal.

## WIRING



Sensor cables must not be laid in parallel in the same cable runs as cables connected to **inductive loads** (i.e. protection solenoids, magnetic rectifiers, motors, etc.), or which conduct currents from **electronic motor drives**. Leads should be kept as short as possible; however, with suitable wiring (low coupling capacitance, small interference voltages), they can be up to 300 m long.

To reduce electromagnetic interference, apply the following measures:

- Maintain the distance to interfering cables > 100 mm
- Use shields
- Install inductances (contactors, magnetic rectifiers, relays) with RC networks or varistors

# PHOTOELECTRIC SENSORS

NEW DESIGNATION SINCE 2013

## LTR-C23PA-PMS-403 (-XXX)

### SENSOR TYPE

Diffuse	LT
Retro-reflex	LR
Through-beam	LL
Background suppression	LH
Distance diffuse	DT
Transparent retro-reflex	TR

### EMISSION TYPE

Red	R
Laser	L
UV	U

### HOUSING TYPE

Cubic	C
Cylindrical threaded	M

### HOUSING SIZE

Cubic 1# mm x 2# mm	12
Cubic 2# mm x 3# mm	23
Cubic 5# mm x 5# mm	55
Cylindrical 18 mm	18

### HOUSING MATERIAL

Plastic	P
---------	---

### PERFORMANCE

Standard	A, B
----------	------

### ADJUSTMENT TYPE

No teach or potentiometer	N
Potentiometer	P
Teach button	T

### SPECIAL EXECUTIONS

#### OUTPUT

##### 4-wire devices, NPN

Light-ON + Dark-ON	01
Light-ON + stability alarm	0A
Dark-ON + stability alarm	0B

##### 4-wire devices, PNP

Light-ON + Dark-ON	03
Light-ON + stability alarm	0C
Dark-ON + stability alarm	0D

##### 3-wire devices, NPN

Light-ON	01
Dark-ON	02

##### 3-wire devices, PNP

Light-ON	03
Dark-ON	04

##### Other

3- or 4-wire through-beam sensor (emitter)	00
Analog	#9
Special	##

4-wire sensor	1
3-wire sensor	3
3-wire sensor with IO-Link	4
4-wire sensor with IO-Link	6

### CONNECTION TYPE

Cable	K
Connector	S
Cable + connector	V

### DETECTION DISTANCE

Short	S
Standard	M
Long	L
Extra long	X

# PHOTOELECTRIC SENSORS

## LTS-1180-303 (-XXX)

PHOTOELECTRIC SENSOR	L
COLOR SENSOR	F
CONTRAST SENSOR	K

### SENSOR TYPE

With analog output	A
For fibers / fiber	F
With background suppression	H
Through-beam sensor	L
Reflex sensor	R
Diffuse sensor	T
Accessories	X
Device with cable	K
Device with connector	S
Device with pigtail	V
Synthetic optical fiber	P
Glass optical fiber	G
Reflector (standard)	R
Reflector for UV light	U
Cutting tool	F
Mounting bracket	W

### SERIES

Cylindrical devices	
Ø 4	1040
M5	1050
M12	1120
M12 laser	112#L
M18	1180
M18 laser	118#L
M18 with lateral light emission	1180W

Rectangular devices	
5 x 7 mm	0507
30x30 mm (high-performance)	3#30
30x30 mm (standard)	3#31
31x60 mm (standard)	3060
31x60 mm (teach-in)	3065
31x60 mm (teach-in & digital display)	3066
31x60 mm (blue light)	3360
40 x 40 mm	4040
40 x 50 mm	415#

Synthetic optical fibers	
Diffuse sensor	1###
Through-beam sensor	2###
Miniature / standard / coaxial	#0##
Flexible	#1##
Luminous (enhanced brightness)	#2##

Glass optical fibers	
Axial diffuse sensor	1###
Radial diffuse sensor	2###
Axial through-beam sensor	3###
Radial through-beam sensor	4###
Accessories	0###

### SPECIAL EXECUTIONS

#### EXECUTION

3- or 4-wire through-beam sensor (emitter)	00
<b>4-wire devices, NPN, output:</b>	
Light-ON + Dark-ON or switchable	01
Light-ON and excess gain	02
<b>4-wire devices, PNP, output:</b>	
Light-ON + Dark-ON or switchable	03
Light-ON and excess gain	04
<b>3-wire devices, NPN, output:</b>	
Light-ON	01
Dark-ON	02
<b>3-wire devices, PNP, output:</b>	
Light-ON	03
Dark-ON	04

### DIMENSIONS

Synthetic optical fibers	
Length in dm (2 m)	020
Length in dm (5 m)	050
Length in dm (10 m)	100
Glass optical fibers	
Length in cm (0.25 m)	025
Length in cm (0.50 m)	050
Length in cm (1 m)	100
Length in cm (2 m)	200
Accessories	
General	###

4-wire through-beam sensor	0
4-wire basic device	1
3-wire through-beam sensor	2
3-wire basic device	3
With IO-Link	4

Inductive

Photoelectric

Safety

RFID

Connectivity

Accessories

Glossary

Index

# PHOTOELECTRIC SENSORS

## LIGHT GRIDS

### DGI-02A-0075-PMS-107

#### LIGHT GRID TYPE

Detection grid	DG
Measurement grid	MG

#### LIGHT SOURCE

Infrared	I
----------	---

#### RESOLUTION / CENTER BEAM SPACING

Resolution in mm (DGI)	##
Center beam spacing in mm (MGI)	##

#### SERIES

Standard	A
----------	---

#### DIMENSIONS

Beam height in mm	####
-------------------	------

#### OUTPUT

Analog	49
Push-Pull	07

#### NUMBER OF WIRES

4-wire	1
--------	---

#### CONNECTION TYPE

Connector	S
-----------	---

#### SENSING RANGE

Standard	M
----------	---

#### ADJUSTMENT TYPE

No potentiometer	N
Potentiometer	P



## ALL OVER THE WORLD

### EUROPE

Austria  
**Belgium\*\***  
Croatia  
Czech Republic  
Denmark  
Estonia  
Finland  
**France\*\***  
**Germany\*\***  
**Great Britain\*\***  
Greece  
Hungary  
Ireland  
**Italy\*\***  
Luxembourg  
Netherlands  
Norway  
Poland  
**Portugal\*\***  
Romania  
Russian Federation  
Slovakia  
Slovenia

Spain  
Sweden  
**Switzerland\*\***  
Turkey  
Ukraine

### AFRICA

Morocco  
South Africa

### THE AMERICAS

Argentina  
**Brazil\*\***  
Canada  
Chile  
**Mexico\*\***  
Peru  
**United States\*\***

### ASIA

**China\*\***  
**India\*\***  
Indonesia

### Japan\*\*

Korea  
Malaysia  
Pakistan  
Philippines  
**Singapore\*\***  
Taiwan  
Thailand  
Vietnam

### AUSTRALASIA

Australia  
New Zealand

### MIDDLE EAST

Israel  
United Arab Emirates

Terms of delivery and right to change design reserved.

\* Status April 2018, own assessment

\*\* Contrinex subsidiary

### HEADQUARTERS

**CONTRINEX AG** Industrial Electronics  
Route du Pâqui 5 - PO Box - CH 1720 Corminboeuf - Switzerland  
**Tel:** +41 26 460 46 46 - **Fax:** +41 26 460 46 40  
**Internet:** www.contrinex.com - **E-mail:** info@contrinex.com



[www.contrinex.com](http://www.contrinex.com)

